



70 RT HP is a new range of 16A to 160A switch disconnectors in isolating material and metal, supplied in a box. Available in control and emergency versions, the range is completed by board versions for front-panel or DIN rail assembly, in 16 to 63A options, all of which can be equipped with auxiliary contacts. These devices have been designed to deliver the ultimate in reliability, functionality and performance. They offer a technologically advanced solution that simplifies installation, reduces wiring times and ensures maximum safety and robustness, even in the most demanding conditions, thanks to the use of high-performance materials.

Versão	Box	Material	Metal
Tipologia	Comando	Corrente nominal (A)	25
N. pólos	2P	Interruptor	Rotary isolator
Grau de protecção	IP66	Resistên. golpes	IK10 (IK08 knob)
Temperatura ambiente	-25 +60 °C	Lid screws (no. and type)	4 metal screws
Furos de entrada	2 x M20 + 2 x M25	Bloqueável	YES (max. 3 locks in ON and OFF)
Tipo acessórios	Max. 2 auxiliary contacts	Current in AC22 (415V)	25
Current in AC23 (415V)	25	Secção cabos	Max 10 mm ²
Dim. externas BxHxP (mm)	140x165x64	Código Electrocod	1742



DIMENSIONAL

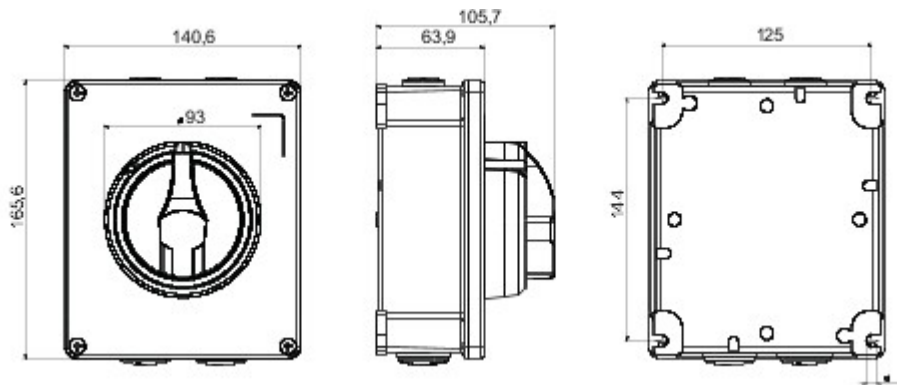

TECHNICAL SYMBOLOGY

IP

IP66

IK

IK10 (IK08 knob)

STANDARDS/APPROVALS

