



Systems of accessories for electrical installations used for residential, tertiary and industrial applications. The system consists of fasteners for pipes and cables, cable fittings, accessories for rigid pipes (RK Series) and flexible conduit (DF Series). The system include also a wide variety of cable ties (52FS Range) and terminal blocks (44 Range).

Renk	Gri RAL 7035	Malzeme	Çarpmaya dayanıklı polimer
Dış borular (mm) için	25	Montaj deliği (mm)	29
Sert borulu IP	IP66	Borulu IP	IP54
Akkor Tel Deneyi:	750 °C	Çalıştırma sıcaklığı	-5 +60 °C
Elektrokod	21221	Standart	EN 61386-1 - EN 60670-1 (uygulanabilir)



DIMENSIONAL

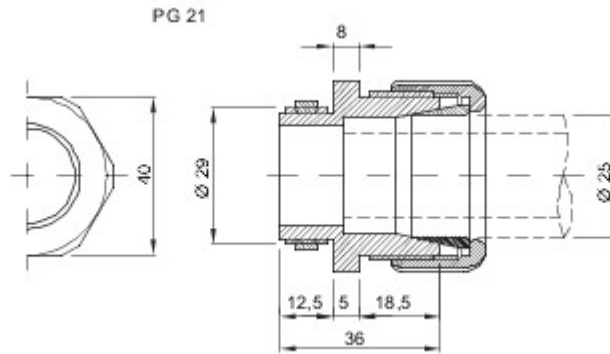

TECHNICAL SYMBOLOGY

GWT

750 °C



-5 +60 °C

STANDARDS/APPROVALS



GEWISS S.p.A. Via A. Volta, 1
24069 Cenate Sotto - Bergamo - Italy
tel. +39 035 94 61 11 fax +39 035 94 69 09

www.gewiss.com
sat@gewiss.com
Last update 14/04/2021

Data, measures, designs and pictures are shown only as informative purposes, and could be changed without previous notice