



70 RT HP is a complete offer of rotary isolator switches from 16 A to 160 A, available in boxes both in insulating material and metal, in control or emergency versions, compatible with the main applications for residential, tertiary and industrial contexts.

DC versions for photovoltaic applications are also available from 16 A to 40 A in insulating box.

The series is completed with versions for board from 16 A to 800 A and for DIN rail fixing from 16 A to 63 A, which can be equipped with auxiliary contacts.

The devices have been designed to reduce wiring time, facilitate installation and guarantee the maximum safety and robustness even in the most demanding conditions.

Wyłączniki	Izolator obrotowy	Wersja	Skrzynka
Materiał	Metal	Typ	Sterowanie
Prąd znamionowy (A)	25	Liczba biegunów	3P
Kolor gałki	Czarny	Zamykany	TAK (maks. 3 blokady w trybie ON i OFF)
Ochrona IP	IP66	Odporność na wstrząsy	IK10 (puszka); IK08 (pokrętko)
Temperatura otoczenia	-25 +60 °C	Śruby pokrywy (nr i typ)	4 metalowe śruby
Prąd w AC21A (415V)	25	otworów wejście	2 x M20 + 2 x M25
Prąd w AC22A (415V)	25	Typ wyposażenie dodatkowe	Maks. 2 styki pomocnicze (1 na stronę)
Prąd w AC23A (415V)	25	Kabel przekrój	1-10 mm <sup>2</sup>



### DIMENSIONAL

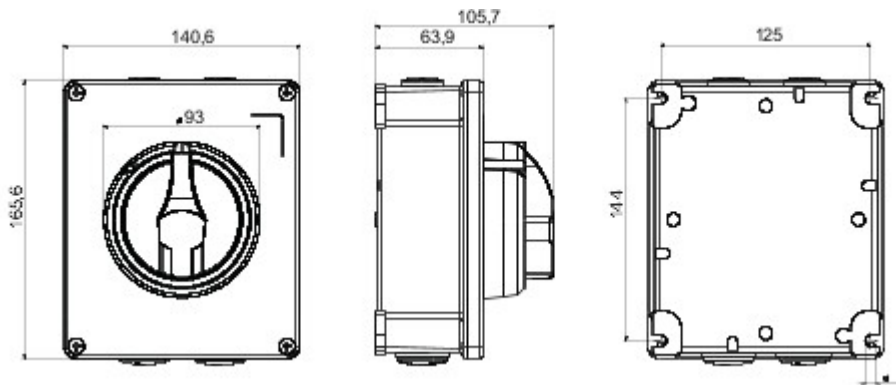

### TECHNICAL SYMBOLOGY

**IP**

IP66

**IK**

IK10 (puszka); IK08 (pokrętko)

### STANDARDS/APPROVALS

