

Grado di protezione	IP66	Potenza dissipabile (W)	34
Resistenza agli urti	> IK10	N. prese IB alloggiabili	3
Prese IB alloggiabili	16/32 A / SELV	N. mod. EN 50022	18
Entrate laterali	2xØ 23	Entrate superiori	5xØ 23/29
Entrate inferiori	1xØ 29/37	Resistenza al filo incandescente	850 °C
Adatto per	Impieghi gravosi	Codice Electrocod	2222
Resistenza agli urti a -20°C	20 J		

### DIMENSIONALE

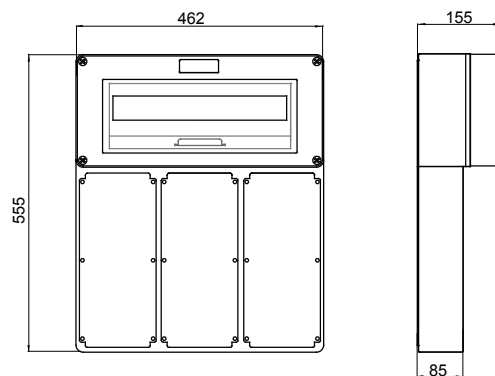

### SIMBOLOGIA TECNICA

**IP**      **IK**      **GWT**

IP66

> IK10

850 °C

### MARCHI/APPROVAZIONI

