

Product Data Sheet

GWJ9262M

JOINON



I-FAST products are JOINON's DC fast-charging solutions ideal for charging all types of electric vehicles equipped with high-voltage systems in private or public high-rotation parking lots, highways and service areas. The offer consists of wallboxes up to 30 kW and stations up to 180 kW. They feature an elegant design and finishes that make them an urban and extra-urban furnishing product, with a graphic display for a better User Experience and use of services for the EV Driver user.

Power specification - AC input		- Environmental	
Input voltage	3Φ 380 + 415 Vac	Operating temperature	-30°C + +50 °C
AC input connection	3P+N+PE (Wye configuration), TN/TT	Humidity	5% + 95% RH, Non-Condensing
Max input current	3Φ 260A	Altitude	≤ 2.000 m
Frequency	50 Hz / 60 Hz	IP degree	IP55
Power factor	> 0.99	Mechanical resistance	IK10 (not including screen & RFID module)
Efficiency	>94%	Cooling method	Fan cooling
Power specification - DC output		- Mechanical	
Output voltage range	CCS2: 150 + 950 Vdc	Dimension	800 mm x 650 mm x 1.900 mm
Max output current	CCS2: 200A (peak at 250A)	Weight	≤500 kg
Maximum output power	180 kW	Cable length	4.5 m
Voltage/Current accuracy	±2%	- Protection	
User interface & control		Input protection	OVP, OCP, OPP, OTP, UVP, RCD, SPD
Display	7" LCD	Output protection	SCP, OCP, OVP, LVP, OTP, IMD
Push buttons	Operation Buttons / Emergency Stop Button	- Regulation	
User Authentication	RFID: support ISO 14443A/B, ISO 15693, FeliCa Lite-S (RCS966), OCPP 1.6 JSON, QR Code, App	Safety	CE, CB
Meter	AC MID Meter, Integrated DC Meter	Certificate	IEC 61851-1, IEC 61851-23, IEC 61851-21-2
Communication		Charging interface	DIN 70121, ISO 15118-2
External	Ethernet, Wi-Fi and 4G	- Contactless Solution	
Internal	CAN bus / RS485	Payment terminal	No

DIMENSIONAL

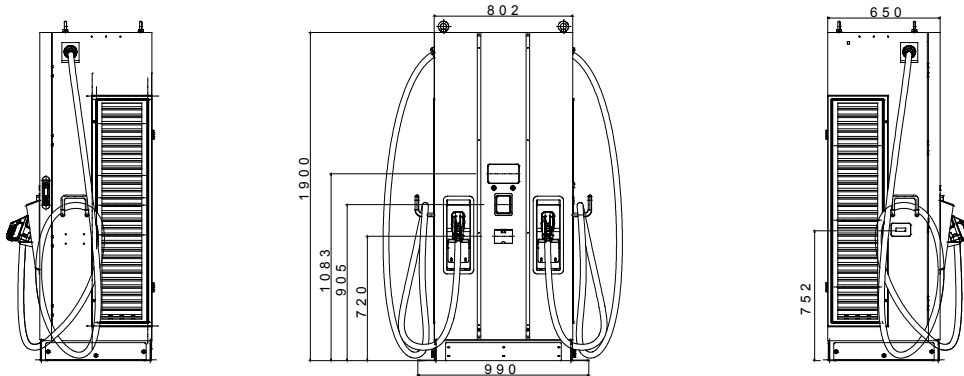

TECHNICAL SYMBOLOGY

IP **IK**

IP55

IK10 (not including screen & RFID module)

STANDARDS/APPROVALS



GEWISS S.p.A. Via Domenico Bosatelli 1
24069 Cenate Sotto - Bergamo - Italy
tel. +39 035 94 61 11 fax +39 035 94 69 09

www.gewiss.com
sat@gewiss.com
Last update 03/07/2024

Data, measures, designs and pictures are shown only as informative purposes, and could be changed without previous notice