

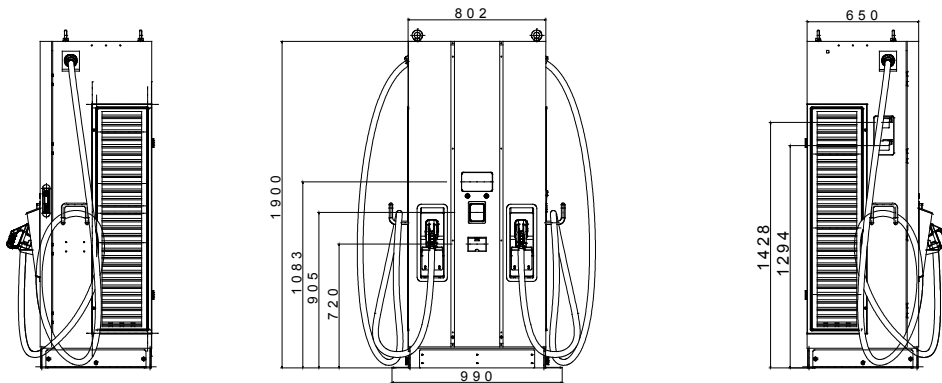

I-FAST products are JOINON's DC fast-charging solutions ideal for charging all types of electric vehicles equipped with high-voltage systems in private or public high-rotation parking lots, highways and service areas. The offer consists of wallboxes up to 30 kW and stations up to 180 kW. They feature an elegant design and finishes that make them an urban and extra-urban furnishing product, with a graphic display for a better User Experience and use of services for the EV Driver user.

<b>Power specification - AC input</b>		<b>Environmental</b>	
Input voltage	3Φ 380 + 415 Vac	Operating temperature	-30°C + +50 °C
AC input connection	3P+N+PE (Wye configuration), TN/TT	Humidity	5% + 95% RH, Non-Condensing
Max input current	3Φ 174A	Altitude	≤ 2.000 m
Frequency	50 Hz / 60 Hz	IP degree	IP55
Power factor	> 0.99	Mechanical resistance	IK10 (not including screen & RFID module)
Efficiency	>94%	Cooling method	Fan cooling
<b>Power specification - DC output</b>		<b>Mechanical</b>	
Output voltage range	CCS2: 150 + 950 Vdc	Dimension	800 mm x 650 mm x 1.900 mm
Max output current	CCS2: 200A (peak at 250A)	Weight	≤420 kg
Maximum output power	120 kW	Cable length	4.5 m
Voltage/Current accuracy	±2%	<b>Protection</b>	
<b>User interface &amp; control</b>		Input protection	
Display	7" graphic	OVP, OCP, OPP, OTP, UVP, RCD, SPD	
Push buttons	Operation Buttons / Emergency Stop Button	Output protection	
User Authentication	OCPP 1.6 JSON, QR Code, App	SCP, OCP, OVP, LVP, OTP, IMD	
Meter	DC PTB Meter	<b>Regulation</b>	
<b>Communication</b>		Accessibility	
External	Ethernet, Wi-Fi and 4G	Reduced component heights for universal accessibility	
Internal	CAN bus / RS485	Safety	
<b>Contactless Solution</b>		Certificate	
Payment terminal	Yes, Payter P66	IEC 61851-1, IEC 61851-23, IEC 61851-21-2	
		Charging interface	
		DIN 70121, ISO 15118-2	
		National	
		-	
		-	

### DIMENSIONAL



### TECHNICAL SYMBOLOGY

**IP**      **IK**

IP55

IK10 (not including screen & RFID module)

### STANDARDS/APPROVALS

