

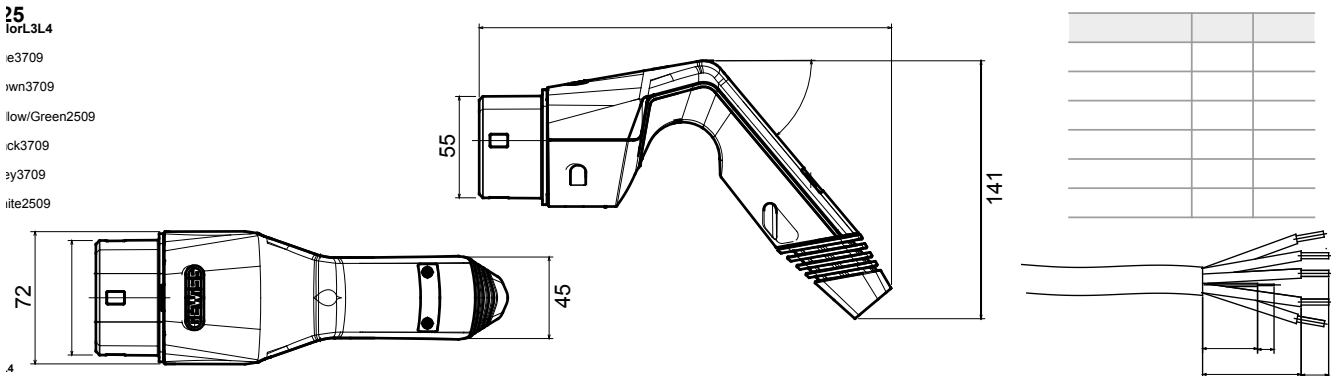

Type 2 mobile connector, compliant with IEC 62196-1 and IEC 62196-2, designed for charging electric vehicles compliant with IEC 61851-1, equipped with an external rubber coating on the lower portion to improve grip and facilitate insertion in the charging inlet. It is supplied pre-wired with a smooth 5 m cable. This product is also equipped with a rubber cable gland and has a IP55 protection rating if inserted in its casing or covered with the protective insulating cover. Customisation options are available for brand, colour and cable length, as well as for cable type and head.

Handle colour	Grey (RAL 7035)	IP degree	IP55 (with sheath or cap)
Overmold colour	RAL 7016	Mechanical resistance	IK10
Cable gland and plug colour	Black RAL 9005	Glow wire test	850°C (active parts) / 650°C (external)
Number of poles	7 (L1, L2, L3, N, PE, CP, PP)	Working temperature	-30°C + +50 °C
Rated current	32 A	Stocking temperature	-40°C + +70°C
Rated voltage	500 V	Wiring section	N/A
Rated frequency (Hz)	50/60 Hz	Insulation voltage (Ui)	500 V
Cable length	5 m	Cable colour	Black
Cable type	Smooth	Cable terminals	Single contacts with ferrules

DIMENSIONAL



TECHNICAL SYMBOLOGY

IP

IK

GWT

IP55 (with sheath or cap)

IK10

850°C (active parts) / 650°C (external)

STANDARDS/APPROVALS

