



Description	Motor switch
Rated operating voltage (Ue)	220 ... 690 V AC
Rated frequency (f)	50/60 Hz
Rated operating current (Ie)	23 A
Setting range (It)	17...23 A
Number of poles	3P
No. modules	2.5

ELECTRICAL CHARACTERISTICS

Standard	IEC/EN 60947-2
Insulation voltage (Ui)	690 V
Rated impulse withstand voltage (Uimp)	6 kV
Overvoltage category	III
Short circuit breaking capacity (Icu)	25 kA (4kA 500V, 3kA 690V)
Short circuit breaking capacity (Ics)	12,5 kA (3kA 500V, 2kA 690V)
Max. back-up fuse, if Icp > Icu	80kA 230V, 63kA 400V, 50kA 500V, 50kA 690V
Power dissipation per pole	2,5 W

PROTECTIONS

Type of protection	Thermo magnetic
Tripping indication	The trip of the protection is signalled by the intermediate position of the START and STOP buttons

MECHANICAL FACTS

Mounting position	Any
Mechanical endurance (O-C cycle number)	100000
Electrical endurance (O-C cycle number)	100000 (AC-3)
IP degree	IP20
Pollution rating	3
Section rigid cable	<=10 mm ²
Section flexible cable	<=6 mm ²
Max. conductor stripping length	10 mm
Rated tightening torque	2 Nm
Operating temperature	-25 +60 °C
Stocking temperature	-25 +70 °C

DIMENSIONAL

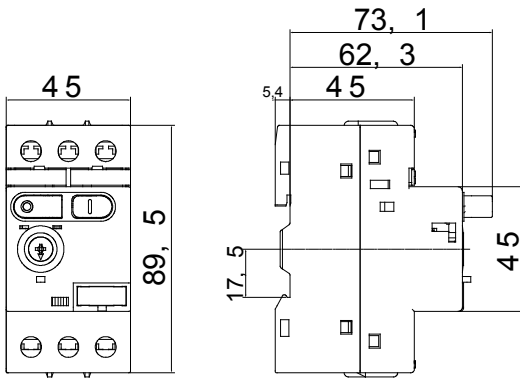

WIRING DIAGRAM

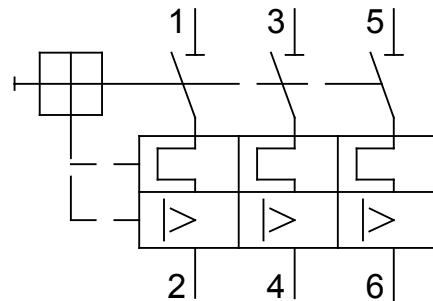

STANDARDS/APPROVALS

