

Product Data Sheet

GW21433

SYSTEM BLACK - Domestic range



The System modular devices allow the creation of an infinite combination of devices and plates, thanks to a complete range that covers all design, functional and installation needs. Colours and finishes: bright and versatile glossy white, and elegant and classy satin black. Ideal for flush-mounted solutions (for rectangular or square boxes), surface-mounted solutions and special applications. The range includes control units, socket-outlets, breakers, indicators, connectors and devices for the control, safety and comfort of the home.

Type	MCB- miniature circuit breaker	Type	Safety
Group	Protection	Description	Single pole (1P)
Curve	C	Class	-
Voltage	230V - 50 / 60 Hz	Rated current (A)	16
Breaking capacity	3 kA	Colour	Black
Standard	EN 60898-1	No. SYSTEM modules	1
Material	Technopolymer	Electrocod	0131

DIMENSIONAL

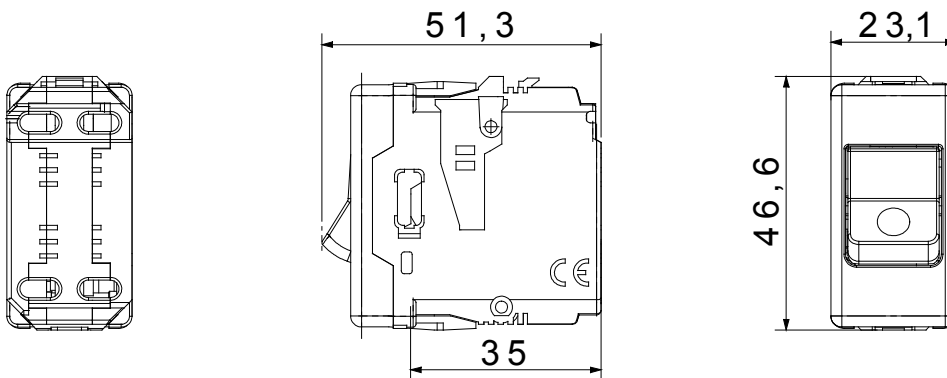

STANDARDS/APPROVALS

