

Wiring devices system characterized by its profile and shape inspired to the Chorus family feeling. Wide range of plates with an Italian design, articulated into two families, GEO and LUX cover plates, available in many materials and finishes. The range is available in three colors: glossy white, satin black, painted titanium and fits in 3x3 inches (1-gang) and 3x6 inches (2-gang) British Standard boxes. Range expandable thanks to the Chorus modular devices.

Family	LUX	Description	1 gang
Colour	Gold	Material	Technopolymer
Finishing	Glossy	Glow wire test	650 °C
Thermo-pressure with ball	70 °C	Standard	EN 60669-1
Electrocod	0110		

DIMENSIONAL

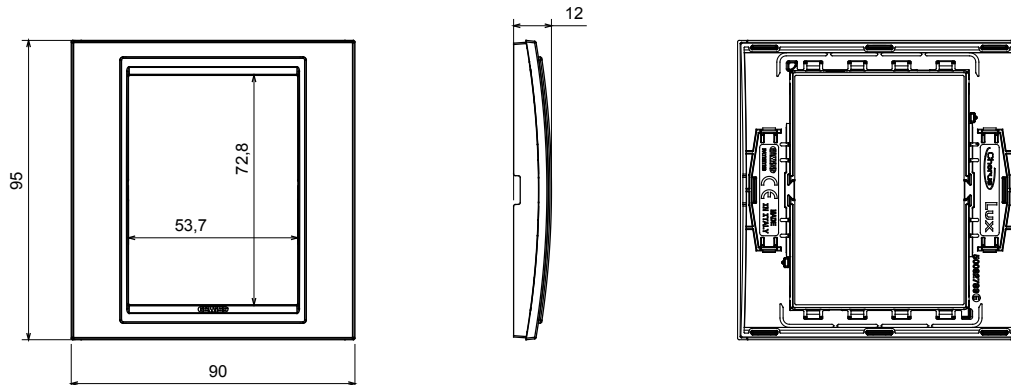

TECHNICAL SYMBOLOGY



STANDARDS/APPROVALS

