



Description Automatic reclosing device
 Code ReStart Autotest PRO 4P
 Rated voltage AC 400 V
 Rated current 25 A
 No. modules 7
 Standard EN 50557, EN 61008-1
 Rated frequency (Hz) 50Hz
 Distribution system TT - TN-S

Rated non-operating resistance between live parts and earth (Rdo)	2,5 kΩ	Insulation voltage (Ui)	500 V
Rated operating resistance between live parts and earth (Rd)	5 kΩ	Rated impulse withstand voltage (Uimp)	4 kV
Maximum operating frequency	30 oper./h	Overvoltage category	III
Mechanical endurance	4000	Dielectric strength test voltage between pole and earth	2500 Vac for 1 minute
Type of residual current protection	A[IR]	Rated residual operating current	300 mA
Operating temperature	-25 +60 °C	Stocking temperature	-40 +70 °C
Type of contacts	Photomos (potential free)	Voltage operating	5-230 V ac/dc
Current operating	0.6mA (min)-100mA cosφ= 1 (max)	Operating frequency	50 Hz
Use category	AC12	Operating modes	NO/NC/NC + pulse
Rated tightening torque	0,4 Nm	Terminal section	≤ 2,5 mm²
Automatic reclosure for untimely tripping	Yes	Earth failure test	Yes
Continuous system monitoring	Yes	Autotest (automatic RCCB protection test)	Yes
Completeable with	GW90992 RS485 BUS Module	Number of poles	4P
Electrocod	1414		

DIMENSIONAL

446

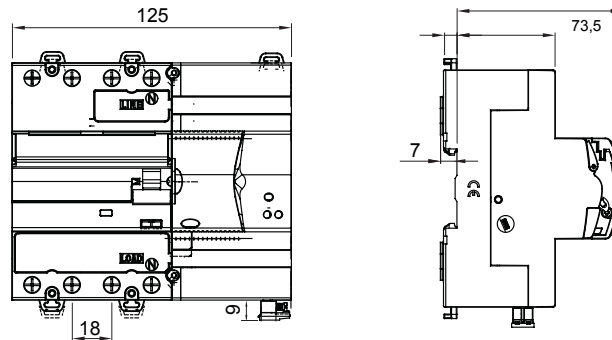

STANDARDS/APPROVALS





Product Data Sheet

GW90927

90 ReStart Range