

The System modular devices allow the creation of an infinite combination of devices and plates, thanks to a complete range that covers all design, functional and installation needs. Colours and finishes: bright and versatile glossy white, and elegant and classy satin black. Ideal for flush-mounted solutions (for rectangular or square boxes), surface-mounted solutions and special applications. The range includes control units, socket-outlets, breakers, indicators, connectors and devices for the control, safety and comfort of the home.

Type	Residual current breaker with overcurrent protection	Type	Safety
Group	Protection	Description	Two-pole (1P+N)
Curve	C	Class	A
Voltage	230V - 50 / 60 Hz	I _{dn}	10 mA
Rated current (A)	16	Breaking capacity	3 kA
Colour	White	Standard	CEI 23-95
No. SYSTEM modules	2	Material	Technopolymer
Electrocod	0131		

DIMENSIONAL

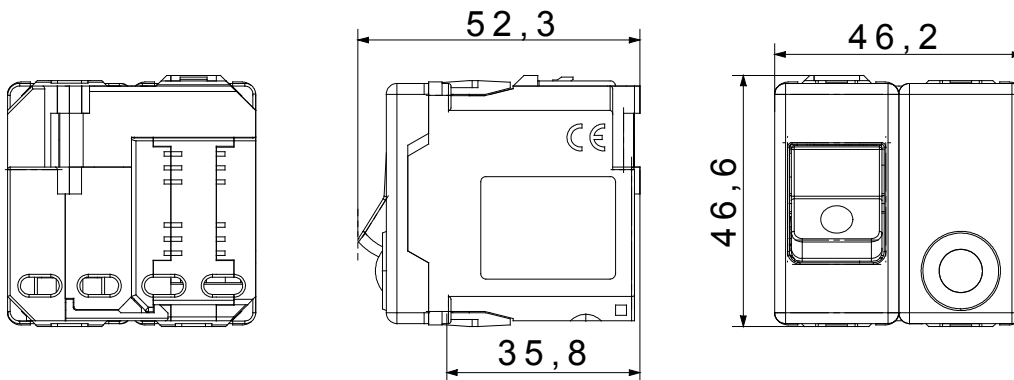

STANDARDS/APPROVALS

