

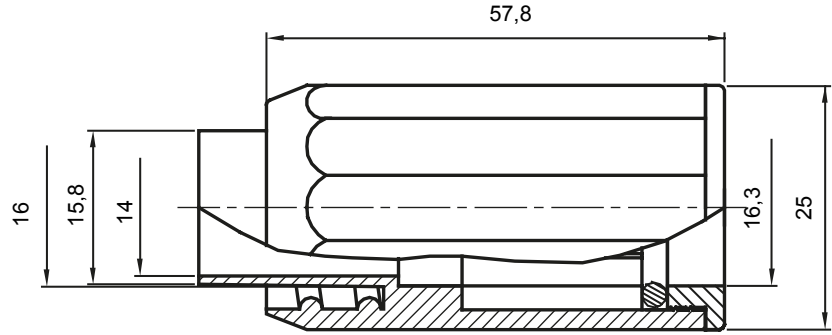

IP40 ve IP67 koruma sınıfına sahip rijit koruyucu borular için yönlendirme bileşenleri.

Renk	Gri RAL 7035	IP derecesi	IP65
Borular Ø (mm)	16	Kılıf Ø (mm)	16
Malzeme tipi	EN 60754-2 uyarınca halojen Free dir	Elektrokod	21221

DIMENSIONAL

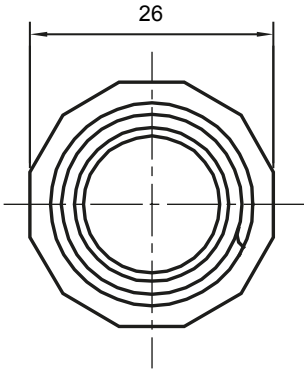

TECHNICAL SYMBOLOGY

IP

HF
HALOGEN FREE

IP65

STANDARDS/APPROVALS

