

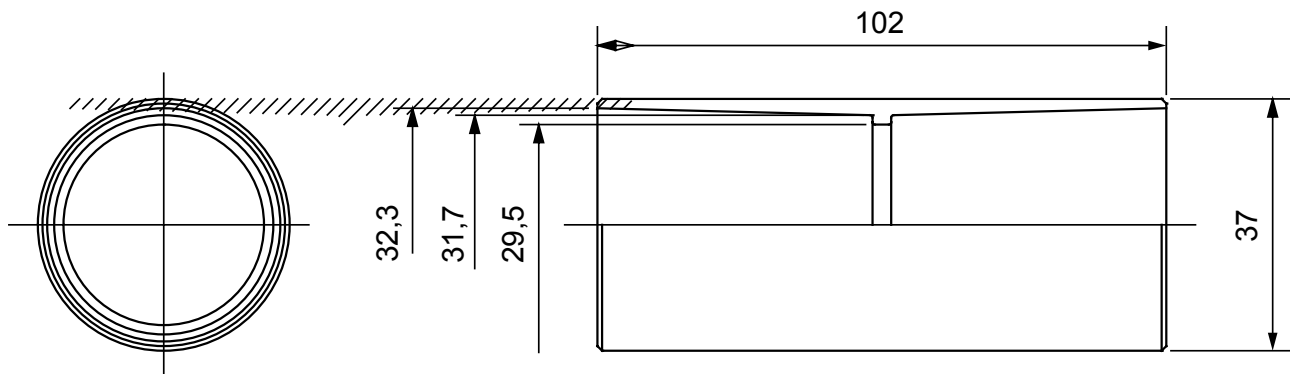

Componente de rutare pentru conducte de protecție rigide cu grad de protecție IP40 și IP67.

Culoare	Gri RAL 7035	Grad IP	IP40
Conducte Ø (mm)	32	Tip material	Fără halogeni în conformitate cu EN 60754-2
Electrocod	21221		

### DIMENSIONAL



### TECHNICAL SYMBOLOGY

IP

HF  
HALOGEN FREE

IP40

### STANDARDS/APPROVALS

