

Culoare	Transparent	Material	PVC
Conducte Ø (mm)	32	Electrocod	210

### DIMENSIONAL

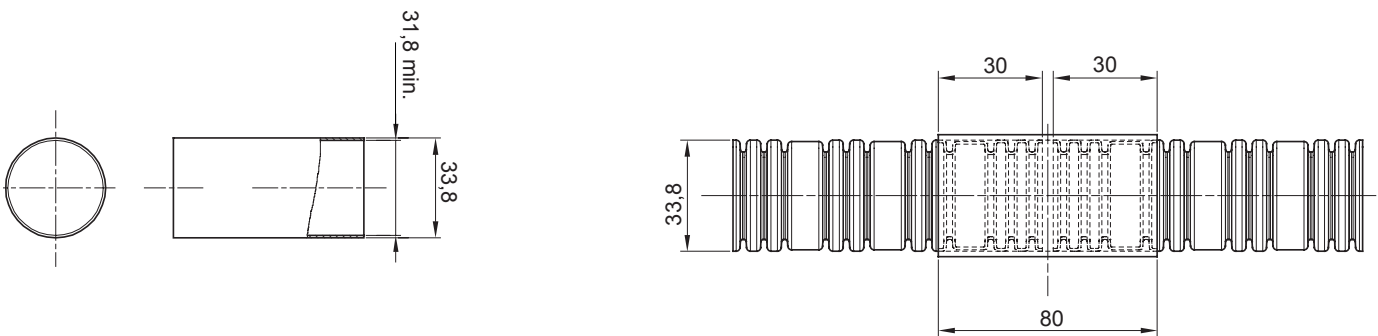

### STANDARDS/APPROVALS

