

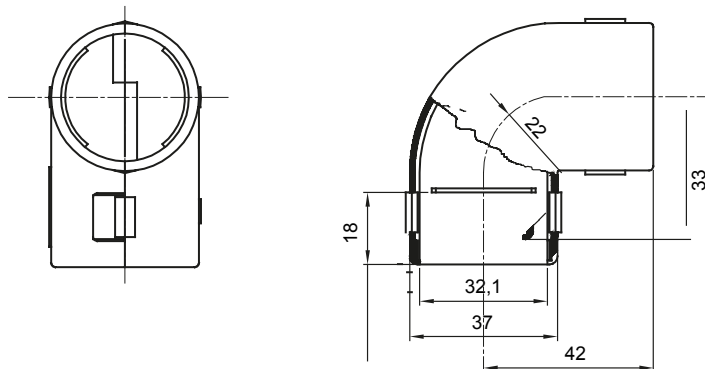

Componente de rutare pentru conducte de protecție rigide cu grad de protecție IP40 și IP67.

Culoare	Gri RAL 7035	Grad IP	IP40
Conducte Ø (mm)	32	Electrocod	21221

DIMENSIONAL



TECHNICAL SYMBOLOGY

IP

IP40

STANDARDS/APPROVALS

