

Pentru plăci LxH (mm)	396x474	Pentru plăci	44 CEP
Tip material	Izolație	Electrocod	1320

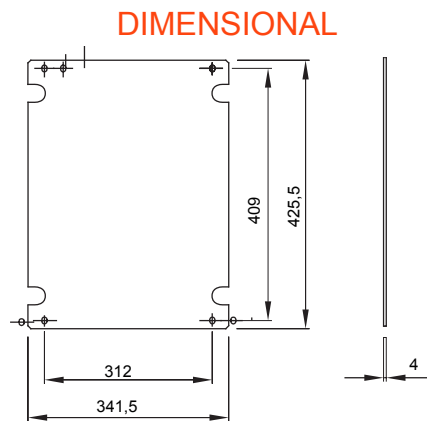

STANDARDS/APPROVALS

