

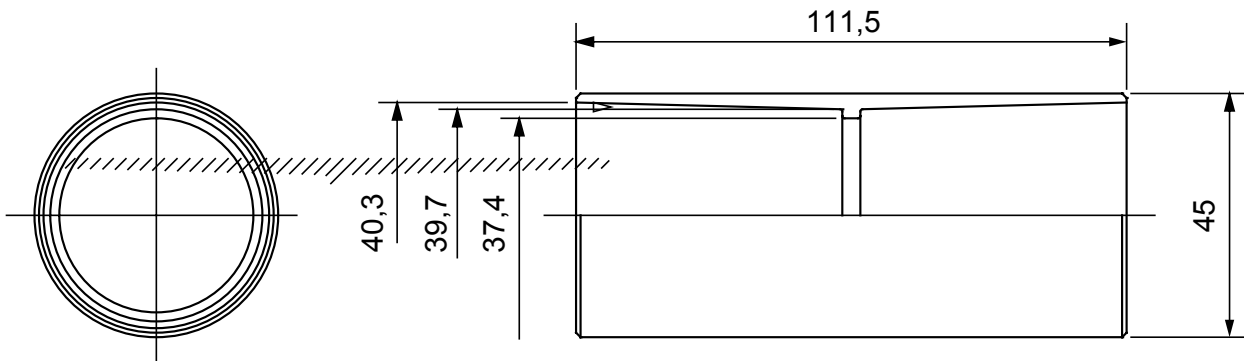

Elementy trasujące do sztywnych rur ochronnych o stopniu ochrony IP40 i IP67.

Kolor	Szary RAL 7035	Ochrona IP	IP40
Ø przewodów (mm)	40	Rodzaj materiału	Bezhalogenowy zgodnie z normą EN 50642
Electrocod	21221		

DIMENSIONAL



TECHNICAL SYMBOLOGY

IP

HF
HALOGEN FREE

IP40

STANDARDS/APPROVALS

