

Product Data Sheet

DX43116

Seria RK



Elementy przeznaczone do trasowania sztywnych osłon kablowych o stopniu ochrony IP40 oraz IP67..

Kolor	Szary RAL 7035	Ochrona IP	IP67
Ø przewodów (mm)	16	Rodzaj materiału	Bezhalogenowe zgodnie z normą EN 50267-2-2
Electrocod	21221		

DIMENSIONAL

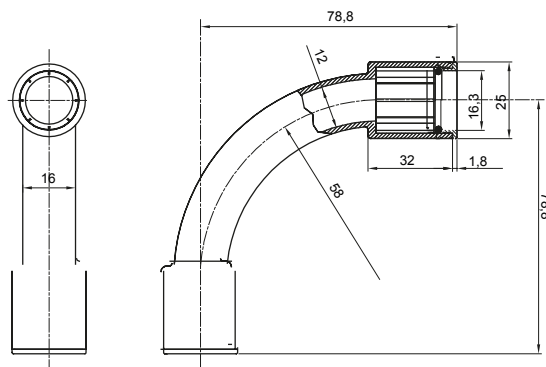

TECHNICAL SYMBOLOGY

IP

HF
HALOGEN FREE

IP67

STANDARDS/APPROVALS



GEWISS S.p.A. Via Domenico Bosatelli 1
24069 Cenate Sotto - Bergamo - Italy
tel. +39 035 94 61 11 fax +39 035 94 69 09

www.gewiss.com
sat@gewiss.com
Last update 07/06/2024

Data, measures, designs and pictures are shown
only as informative purposes,
and could be changed without previous notice