

Product Data Sheet

DX43040

Seria RK



Elementy przeznaczone do trasowania sztywnych osłon kablowych o stopniu ochrony IP40 oraz IP67..

Kolor	Szary RAL 7035	Ochrona IP	IP67
Ø przewodów (mm)	40	Rodzaj materiału	Bezhalogenowe zgodnie z normą EN 50267-2-2
Electrocod	21221		

DIMENSIONAL

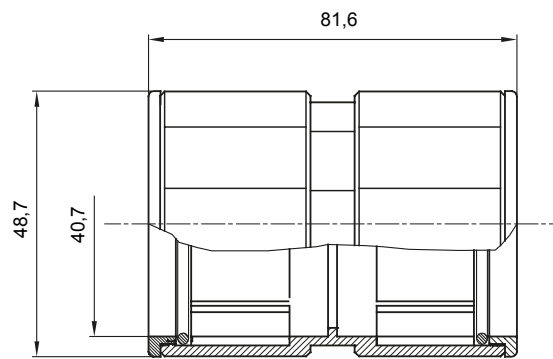
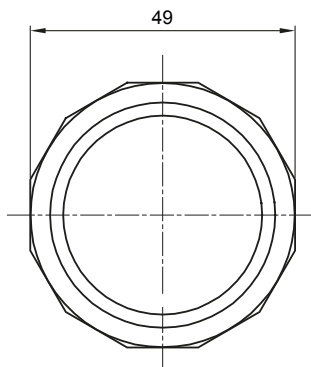

TECHNICAL SYMBOLOGY

IP

HF
HALOGEN FREE

IP67

STANDARDS/APPROVALS

