

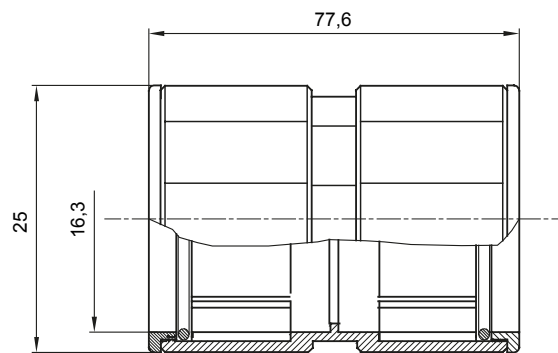

Routingonderdelen voor rigide beschermende buizen met beschermingsgraad IP40 en IP67.

Kleur	Grijs RAL 7035	IP graad	IP67
Buizen Ø (mm)	16	Type materiaal	Halogenvrij conform EN 50642
Electrocod	21221		

### DIMENSIONAL

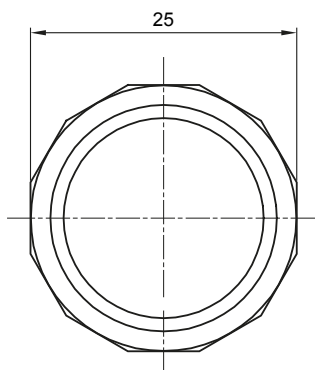

### TECHNICAL SYMBOLOGY



IP67

### STANDARDS/APPROVALS

