

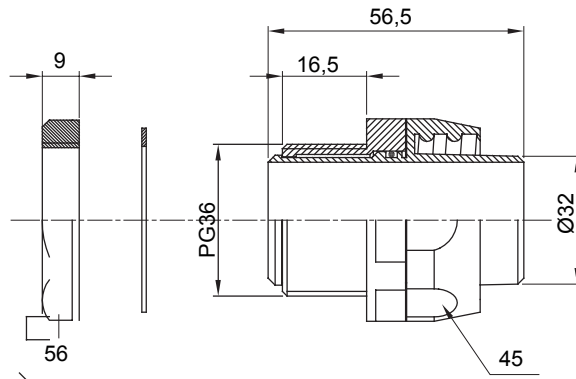

Straight and revolving coupling device for sheath with IP54 protection degree.

Colour	Grey RAL 7035	IP degree	IP54
PG pitch	36	Sheath Ø (mm)	32
Type of pitch	PG36	Type	Revolving
Electrocod	210		

### DIMENSIONAL



### TECHNICAL SYMBOLOGY

**IP**

IP54

### STANDARDS/APPROVALS

