

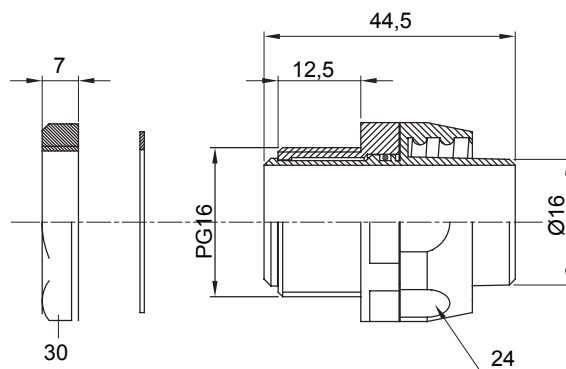

Straight and revolving coupling device for sheath with IP54 protection degree.

|               |               |               |           |
|---------------|---------------|---------------|-----------|
| Colour        | Grey RAL 7035 | IP degree     | IP54      |
| PG pitch      | 16            | Sheath Ø (mm) | 16        |
| Type of pitch | PG16          | Type          | Revolving |
| Electrocod    | 210           |               |           |

### DIMENSIONAL



### TECHNICAL SYMBOLOGY

# IP

IP54

### STANDARDS/APPROVALS

