

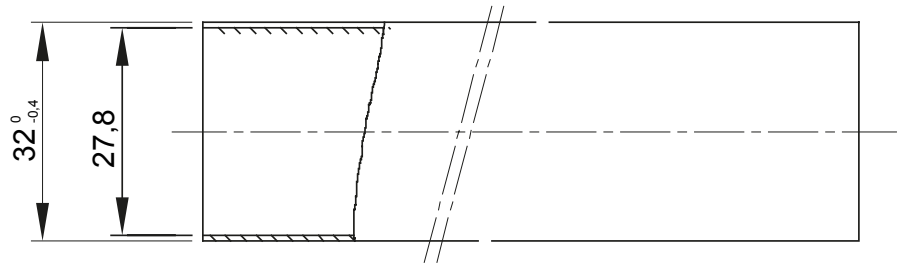

The system of medium rigid protective conduits made of high quality PVC to offer superior performance. Available in diameters from 16 to 32 mm and in lengths from 2 to 3 m. They can be integrated with flexible conduits and junction boxes. Completing the offer, a wide range of couplings and routing components with IP40 and IP67 degree of protection.

Colour	Grey RAL 7035	Material	PVC
Length (m)	3	Conduits Ø (mm)	32
Glow Wire Test	960 °C	Electrocod	21220
Resistance to compression	3 (Medium - 750 N)	Resistance to impact	3 (Medium - 2 J)
Resistance to bending	1 (Rigid)	Electrical characteristics	2 (With electrical insulating characteristics)
Protection against ingress of solid objects without accessories	0	Protection against ingress of water objects without accessories	0
Resistance against corrosion	Not applicable to plastic conduit systems	Fire resistance	1 (Non-flame propagating)
Insulation resistance	100 MΩ a 500V for 1 minute	Protection against ingress of solid objects with accessories	4/6 (It depends on the accessories used)
Protection against ingress of water with accessories	0/5/7 (It depends on the accessories used)	Dielectric rigidity	2000 V a 50 Hz for 15 minutes
Standard	EN 61386-1 EN 61386-21	Family	IRL/B
Classification	33211	Conduit type	Sleeved

### DIMENSIONAL

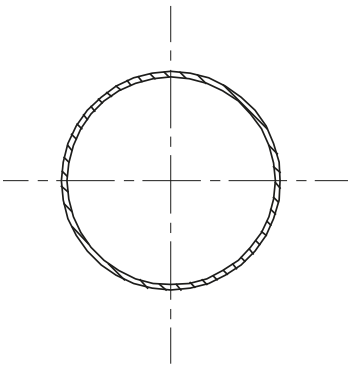

### TECHNICAL SYMBOLOGY



### STANDARDS/APPROVALS

