

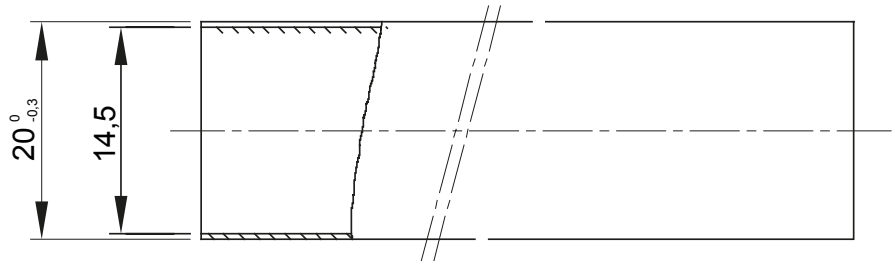

Rigid protected conduit system range RKHF made in thermoplastic PP material, Halogen Free in compliance with EN 60754-2, classification 4422. In compliance with IEC 61386-1 (CEI 23/80) e IEC 61386-21 (CEI 23/81). The conduits are available in: 4 sizes from 16 to 32 mm for length 3 metres, 7 sizes from 16 to 63 mm for length 2 metres. Suitable for electrical systems and/or data transmission, particularly in public places (schools, cinemas, theatres). Installation type: exposed on walls and ceilings or for applications inside false ceilings and floating floors.

| | | | |
|---|--|---|--|
| Colour | Grey RAL 7035 | Material | PP |
| Length (m) | 3 | External Ø conduits (mm) | 20 |
| Internal Ø conduits (mm) | 14.5 | Type of material | Halogen-free in compliance with EN 60754-2 |
| Electrocod | 21220 | Resistance to compression | 4 (Heavy - 1250 N) |
| Resistance to impact | 4 (Heavy - 6 J) | Resistance to bending | 1 (Rigid) |
| Electrical characteristics | 2 (With electrical insulating characteristics) | Protection against ingress of solid objects without accessories | 0 |
| Protection against ingress of water objects without accessories | 0 | Resistance against corrosion | Polypropylene naturally resistant to corrosion |
| Fire resistance | 1 (Non-flame propagating) | Insulation resistance | 100 MΩ a 500V for 1 minute |
| Protection against ingress of solid objects with accessories | 4/6 (It depends on the accessories used) | Protection against ingress of water with accessories | 0/5/7 (It depends on the accessories used) |
| Dielectric rigidity | 2000 V a 50 Hz for 15 minutes | Standard | EN 61386-1 EN 61386-21 |
| Family | RKHF | Classification | 4422 |

DIMENSIONAL

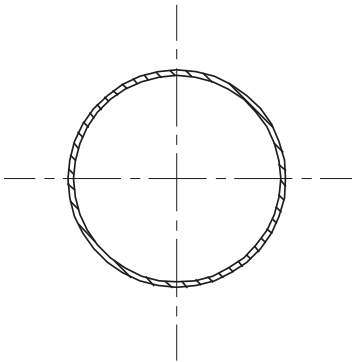

TECHNICAL SYMBOLOGY



STANDARDS/APPROVALS

