

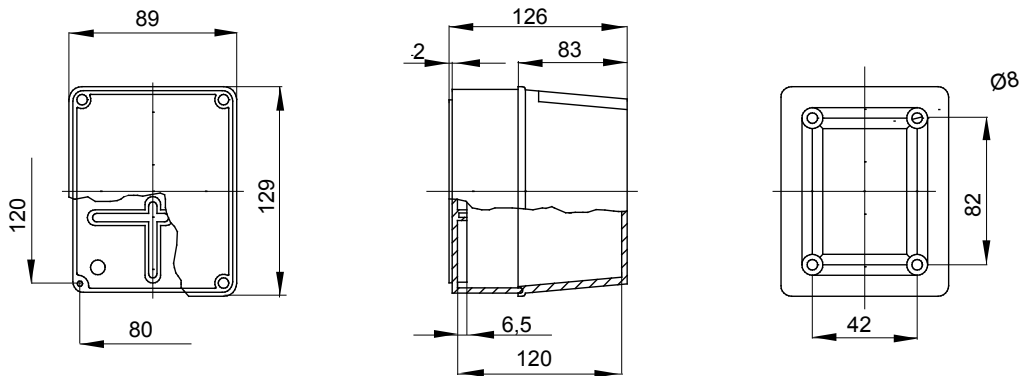

Range 44 CE - Surface-mounting watertight junction boxes in compliance with EN 60670-1 (CEI 23-48) and IEC 60670-22 (CEI 23-94) and made in high-performance technopolymers. The range includes versions with protection degree IP44, IP55, IP56 with smooth walls or with quick entry cable glands and different type of covers: blind / transparent, deep/plain, press-on/screw (in plastic, also 1/4 turn, or in metal). Available in different self-extinguishing materials (up to GWT 960 °C). Suitable for ordinary junctions, for special uses, and for industrial uses.

Insulation class	II (according to IEC 61140 standards)	Colour	Grey RAL 7035
IP degree	IP56	Material	Technopolymer GWPLAST 75
Mechanical resistance	IK08	Internal dim. LxHxD (mm)	120x80x120
Max Ø holes possible	29 mm	Lid screws (no. and type)	4 - Stainless steel
Application	Special uses	Glow Wire Test	960 °C
Lid	Deep screwed	Operating temperature	-25 +60 °C
Electrocod	02211	Thermo-pressure with ball	85 °C
Torque screws tightening	1 Newton/Meter	Walls	Smooth
Accessories for insulation restoring	GW44622		

### DIMENSIONAL



### TECHNICAL SYMBOLOGY



### STANDARDS/APPROVALS

