

Range of Watertight surface-mounting boards made metallic material. In compliance with IEC 61439-1 (CEI 17/113), IEC 61439-2 (CEI 17/114), IEC 60670-1 (CEI 23/48), IEC 60670-24 (CEI 23/49) e IEC 62208 (CEI 17-87). Available in 7 sizes, transparent and black door versions with IP55 protection degree. Fast&Easy accessories, made in metal, allow the installation of modular devices and moulded-case circuit breakers up to 250A into the boards, reducing assembly times by up to 40%. Indicated for automation and distribution for indoor applications.

Insulation class	Pre-arranged with earth terminal	Colour	Grey RAL 7035
Nominal dim. LxHxD (mm)	405x650x200	IP degree	IP55
Material	Sheet metal from 10/10 to 15/10, painted with epoxy-polyester powders	Mechanical resistance	IK10
No. locks	2	No. of modules EN 50022	72 (18x4)
Application	For indoor use	Dispersible power A (W)	135
Dispersible power B (W)	97	Functional dim. LxHxD (mm)	405x650x200
Operating temperature	-25 +60 °C	Type of material	Metal
Electrocod	0320	Standard	EN 61439-1, EN 61439-2, EN62208, EN 60670-1, IEC 60670-24
Family	46 QM	Maximum rated insulation voltage (Ui)	690 V
Type of door	Blank door		

DIMENSIONAL

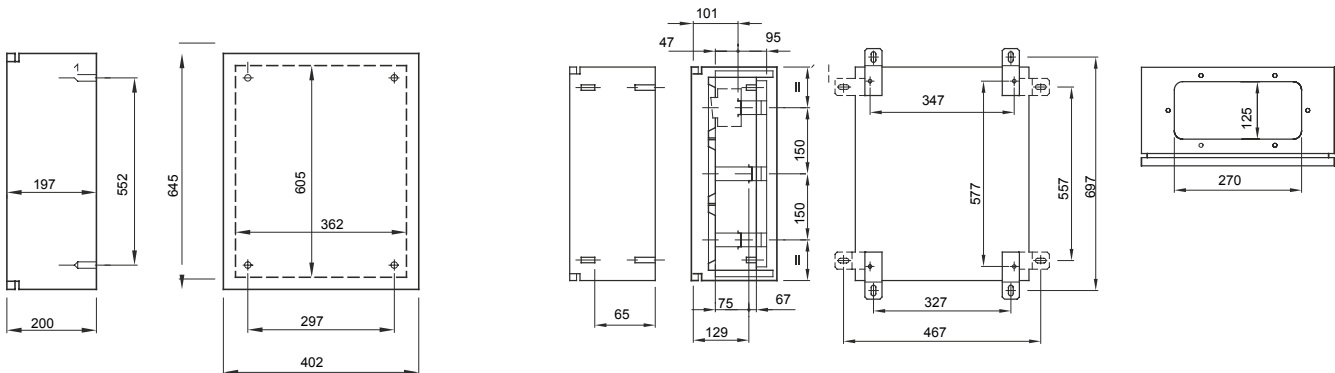

TECHNICAL SYMBOLOGY

IP

IP55

IK

IK10

STANDARDS/APPROVALS

