

Range of Watertight surface-mounting boards made in thermoplastic material GW PLAST 120. In compliance with IEC 61439-1 (CEI 17/113), IEC 61439-2 (CEI 17/114), IEC 60670-1 (CEI 23/48) e IEC 60670-24 (CEI 23/49). Available in 4 sizes, transparent and black door versions with IP55 protection degree. Accessories available: panels with window complete with extrable frames, for modular devices and moulded-case circuit breakers up to 160A. Indicated for automation and distribution.

Insulation class	II	Colour	Grey RAL 7035
Outer dim. LxHxD (mm)	316x396x160	IP degree	IP55
Material	Technopolymer GWPLAST 120	Mechanical resistance	IK08
No. locks	2	No. of modules EN 50022	24 (12X2)
Dispersible power A (W)	42	Dispersible power B (W)	34
Glow Wire Test	650 °C	Operating temperature	-25 +60 °C
Insulation voltage (Ui)	750 V	Type of material	Halogen-free in compliance with EN 60754-2
Electrocod	1312	Thermo-pressure with ball	110 °C
Accessories for insulation restoring	GW44621-GW46446-GW46451	Standard	EN 61439-1, EN 61439-2, EN60670-1, IEC 60670-24
Family	44 CEP	Maximum rated insulation voltage (Ui)	750 V
Type of door	Blank door		

DIMENSIONAL

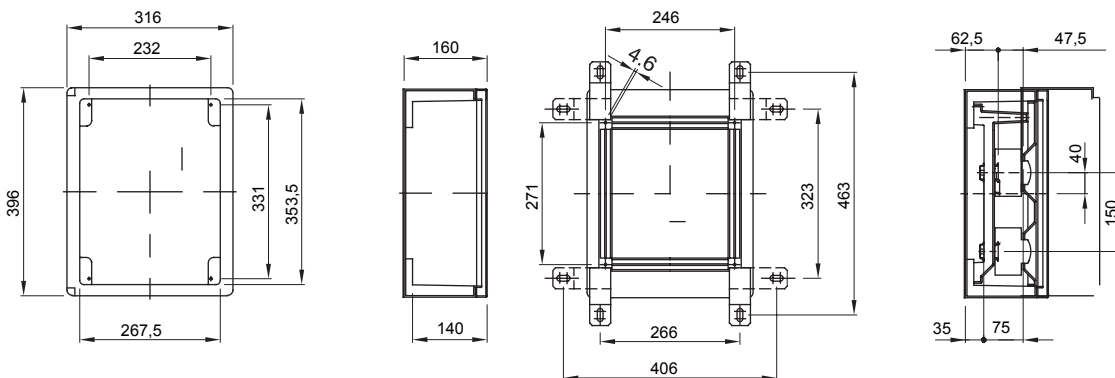

TECHNICAL SYMBOLOGY



II

IP

IP55

IK

IK08

GWT

650 °C



Halogen-free in compliance with EN 60754-2



110 °C

STANDARDS/APPROVALS

