

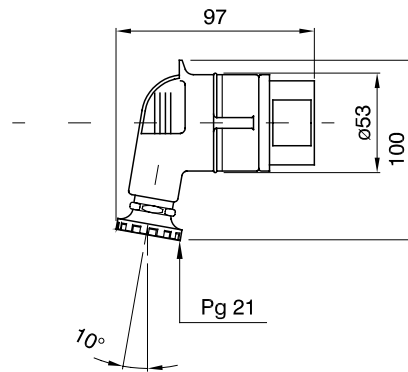

A range of trailing and fixed plugs and socket-outlets for industrial use, complying with the dimensional and performance standards unified at International level (IEC 60309) and assimilated by the European Standards (EN 60309) and Italian Standards (CEI 23-12). Socket-outlets and plugs with a rated current of 63 and 125A are equipped with an extra pilot contact (CP) for creating an electric interlock. The range is completed with 90° fixed plugs and 10° and 90° fixed socket-outlets. Sleeves and pins are obtained from solid brass bar, type Pt. CuZn40Pb2 (Cu 58%, Zn 40%, Pb 2%); anti-loosening terminals with unlosable screws, and built-in cable clamp with anti-abrasion cable gland.

Colour	Green	Rated current (A)	16	
IP degree	IP44	No. of poles	2P	
Mechanical resistance	IK08	Reference h	11	
Type	90° plug	Rated voltage	20-25V and 40-50 V	
Frequency	401 - 500 Hz	Terminal tightening capacity	1-2.5mm ² flexible cables - 1.5-4mm ² rigid cables	
Cable clamp tightening capacity	7.5-13.2 mm	Operating temperature	-25 +40 °C	
Type of wiring	With screw	Electrocod	2230	
Glow wire test	850 °C (active parts) - 650 °C (passive parts)		Total number of operations	> 5000
Permissible overload	22 A	Breaking capacity at 1.1 Un	20 A	
Insulation resistance	> 10 MΩ	Thermo-pressure with ball	125 °C (active parts) - 80 °C (passive parts)	

DIMENSIONAL



TECHNICAL SYMBOLOGY

IP

IP44

IK

IK08



With screw

GWT

850 °C (active parts)
- 650 °C (passive parts)



125 °C (active parts)
- 80 °C (passive parts)

STANDARDS/APPROVALS

