

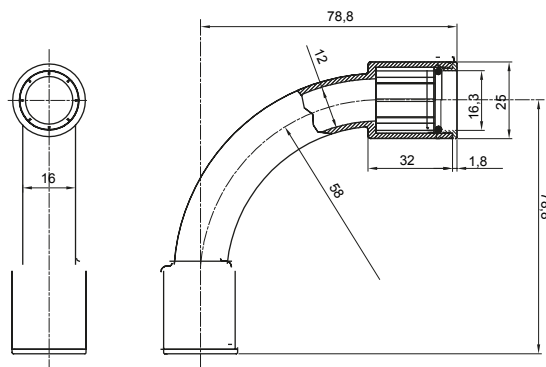

Componenti di percorso per i tubi protettivi rigidi serie RK con gradi di protezione IP40 e IP67.

Colore	Grigio RAL 7035	Grado di protezione	IP67
Tubi Ø (mm)	16	Tipo Materiale	Halogen free secondo norma EN 50642
Codice Electrocod	21221		

DIMENSIONALE



SIMBOLOGIA TECNICA



IP67

MARCHI/APPROVAZIONI

