

| | | | |
|-----------------|-------------|------------|-----|
| Couleur | Transparent | Matière | PVC |
| Conduits Ø (mm) | 25 | Electrocod | 210 |

DIMENSIONS

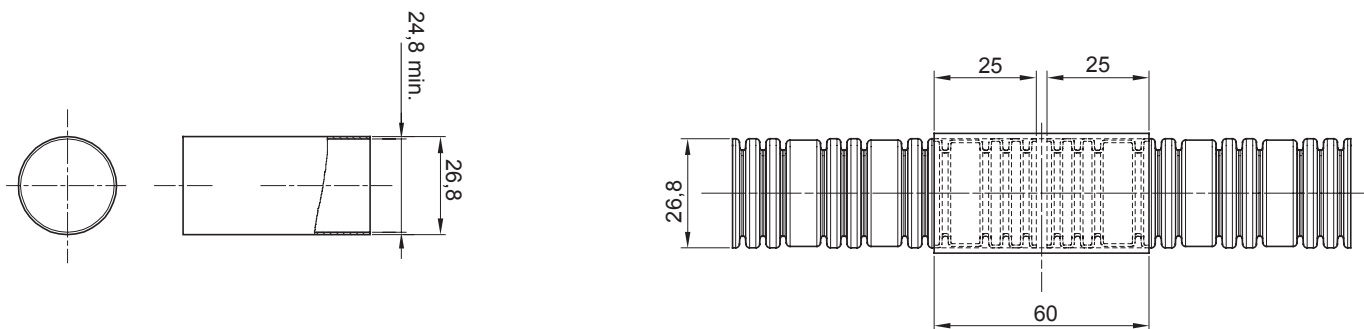

NORMES ET HOMOLOGATIONS

