



Description	Disjoncteur moteur
Rated operating voltage (Ue)	220 ... 690 V AC
Rated frequency (f)	50/60 Hz
Rated operating current (Ie)	32A
Setting range (It)	25...32 A
Nombre de pôles	3P
N. de modules	2,5

ELECTRICAL CHARACTERISTICS

Norme	IEC/EN 60947-2
Tension d'isolement (Ui)	690 V
Tension nominale tenue à l'impulsion (Uimp)	6 kV
Catégorie de surtension	III
Pouvoir de coupure	25 kA (4kA 500V, 3kA 690V)
Short circuit breaking capacity (Ics)	12,5 kA (3kA 500V, 2kA 690V)
Max. back-up fuse, if Icp > Icu	80kA 230V, 63kA 400V, 50kA 500V, 50kA 690V
Puissance dissipée par pôle	2,5 W

PROTECTIONS

Type of protection	Thermo magnetic
Tripping indication	The trip of the protection is signalled by the intermediate position of the START and STOP buttons

CARACTERISTIQUES MÉCANIQUES

Mounting position	Tout
Mechanical endurance (O-C cycle number)	100000
Electrical endurance (O-C cycle number)	100000 (AC-3)
Degré IP	IP20
Taux de pollution	3
Section fil rigide	<=10 mm ²
Section fil souple	<=6 mm ²
Max. conductor stripping length	10 mm
Couple de serrage nominal	2 Nm
Température d'utilisation	-25 +60 °C
Température de stockage	-25 +70 °C

DIMENSIONS

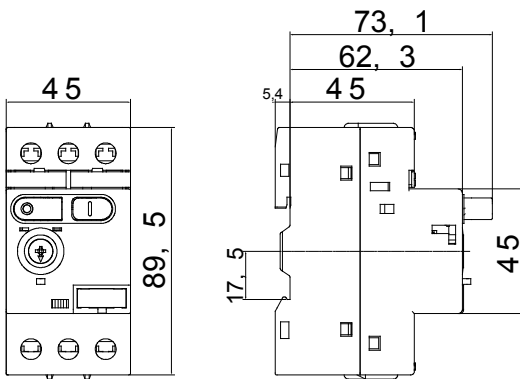

SCHEMA ELETTRICO

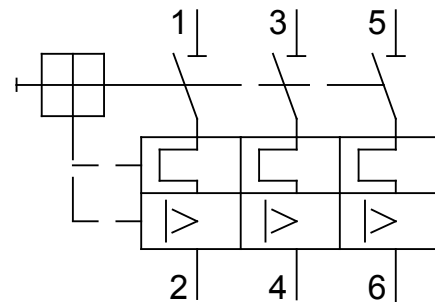

NORMES ET HOMOLOGATIONS

