

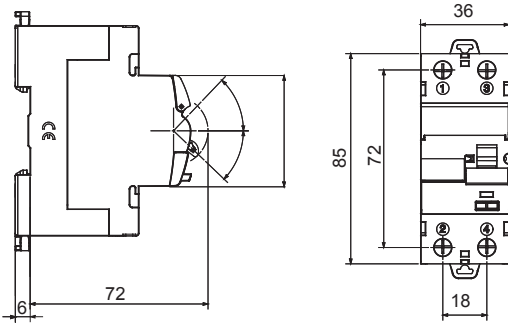

Description	INTERRUPTEUR DIFFÉRENTIEL
Code	IDP
Nombre de pôles	2P
Nombre de modules	2
Courant nominal	40 A
Courant résiduel nominal	500 mA
Type	A
Tension nominale (EN/IEC 61008-1, 61008-2-1)	230/240 V

Norme	IEC/EN 61008-1, IEC/EN 61008-2-1	Fréquence nominale (Hz)	50/60 Hz
Tension d'isolement (Ui)	500 V	Tension nominale tenue à l'impulsion (Uimp)	4 kV
Catégorie de surtension	III	Niveau d'immunité (8/20 µs)	250 A
Section fil rigide	<=1x35 - <=2x16 - <=1x16+2x10 mm²	Section fil souple	<=1x35 - <=2x16 - <=1x16+2x10 mm²
Couple de serrage nominal	3 Nm	Double connexion	OUI (bornes amont et aval)
Température d'utilisation	-25 +60 °C (40 °C avec déclassement)	Température de stockage	-40 +70 °C
Endurance électrique	≥ 10.000	Endurance mécanique	≥ 20000
Compatibilité avec auxiliaires électriques	Oui	Compatibilité avec ReStart	Oui
Position de montage	Tout		

DIMENSIONS



SCHEMA ELETTRICO



NORMES ET HOMOLOGATIONS

