



Description	BLOC DIFFÉRENTIEL
Code	BD
Nombre de pôles	4P
Nombre de modules	3,5
Courant nominal	63 A
Courant résiduel nominal	30 mA
Type	A
Tension nominale (IEC/EN 61009-1 annexe G, IEC/EN 61009-2-1 annexe G)	400 V

Norme	IEC/EN 61009-1 app. G, IEC/EN 61009-2-1 app. G	Fréquence nominale (Hz)	50/60 Hz
Tension d'isolement (Ui)	500 V	Tension nominale tenue à l'impulsion (Uimp)	4 kV
Catégorie de surtension	III	Niveau d'immunité (8/20 µs)	250 A
Section fil rigide	Max 35 mm <sup>2</sup>	Section fil souple	Max 35 mm <sup>2</sup>
Température d'utilisation	-25 +40 °C	Température de stockage	-40 +70 °C
Couple de serrage nominal	2 Nm	Position de montage	Tout

### DIMENSIONS



### SCHEMA ELETTRICO

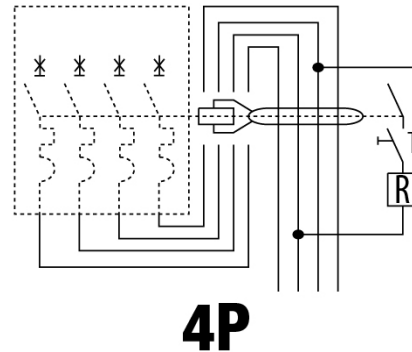

### NORMES ET HOMOLOGATIONS

