

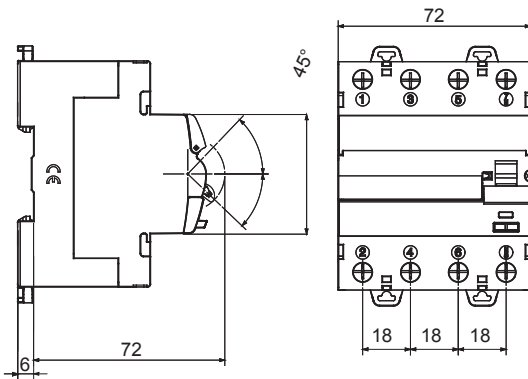

Beschreibung	FEHLERSTROM-SCHUTZSCHALTER
Artikelnr.	IDP
Anz. Pole	4P
Anz. TE EN 50022	4
Bemessungs- strom	25 A
Bemessungsfehlerstrom	300 mA
Typ	A
Bemessungsspannung (EN/IEC 61008-1, 61008-2-1)	400/415 V

Norm	IEC/EN 61008-1, IEC/EN 61008-2-1	Bemessungs- frequenz (Hz)	50/60 Hz
Isolationsspannung (Ui)	500 V	Bemessungsstoß spannungsfestigkeit (Uimp)	4 kV
Überspannungs- kategorie	III	Stoßstromfestigkeit (8/20 µs)	250 A
Anschlussquerschnitt starre Leiter	<=1x35 - <=2x16 - <=1x16+2x10 mm²	Anschlussquerschnitt flexible Leiter	<=1x35 - <=2x16 - <=1x16+2x10 mm²
Anzugsdrehmoment	3 Nm	Doppelter Anschluss	JA (oben und unten)
Betriebstemperatur	-25 +60°C (40°C mit Derating)	Lagertemperatur	-40 +70 °C
Elektrische Lebensdauer	≥ 10.000	Mechanische Lebensdauer	≥ 20000
Kompatibilität zu elektrischen Hilfsschaltern	Ja	Kompatibilität zu ReStart	Ja
Position Montage	Jeder		

Abmessungen



Schaltplan



Normen / Richtlinien

