

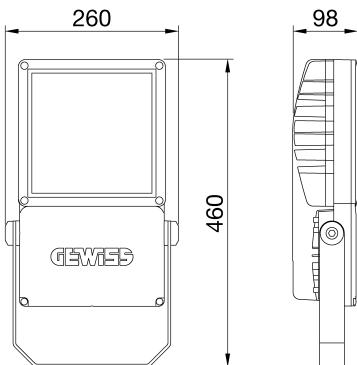

SMART [PRO]e 1M is a medium-power outdoor and indoor LED floodlight, ideal for lighting small to medium-sized areas and sports facilities. It can be installed on the wall, ceiling or ground thanks to the galvanised steel bracket which is powder coated in polyester with trivalent passivation and equipped with an adjustable goniometric scale and supplied in kit form. The main body is made in die cast aluminium EN AB 46100, with an integrated passive heat sink, and powder coated polyester frame with trivalent passivation. COB LED technology for high efficacy. Reflector made of metallised PC-HT or anodised and polished aluminium. 4mm thick toughened front glass, silkscreen printed for symmetrical versions or with anti-reflective nanocoating for asymmetrical versions. Anti-ageing silicone gaskets and A2 stainless steel exterior screws. Plastic venting and anti-condensation device. Electrical connection via 5x1mm² H07RN-F cable. Insulation Class 1. Built-in 1-10V dimmable driver. Available with five different types of optics, three types of Correlated Colour Temperature (3000K/4000K/5700K) and two different types of Colour Rendering Index (CRI70, CRI80). Designed to withstand surges up to 6KV (differential mode) and 10KV (common mode), temperature variations from -30°C to +40°C, water and dust penetration up to IP66, and impact up to IK08.

ALGEMENE INFORMATIE		OPTISCHE EN VERLICHTINGSKENMERKEN	
Context	Schijnwerpers en kleine tot middelgrote sportfaciliteiten	Optiek	SM - Symmetrisch Medium
Armatuur	LED-armatuur met gemiddeld lumenvermogen	Unified Glare Rating	G*6 - ULOR = 0%
Toepassing	Binnen / Buiten	Lumen output (lm)	20900
Unieke digitale code (Datamatrix)	Momenteel niet aanwezig	Effectiviteit (lm/W)	139
Kleur	Grafietgrijs	Kleur temperatuur	3000 K
Soort lichtbron	Led - niet vervangbaar	Kleurweergave-index (CRI)	CRI>80
Systeem vermogen	150 W	Kleurconsistentie (SDCM)	SDCM = 3
Levensduur led	L90B10 (Tq+25 °C) = 100000u; L80B10 (Tq+25 °C) > 150000u	Fotobiologisch risicoklasse	RG1
Gewicht (kg)	5.7	Standaard	EN60598-1; EN60598-2-5; IEC62778; EN13201
Garantie	5 jaar	ELEKTRISCHE EN VERLICHTINGSKENMERKEN	
Opslagtemperatuur	-	Voeding voltage	220 - 240 V
Bedrijfstemperatuur	-30 +40 °C	Nominale frequentie (Hz)	50 / 60
MATERIALEN		Driver	Inbegrepen
Behuizing	Gegoten aluminium -	Uitvalpercentage driver	F10 = 100.000u Tq25 °C
Schildtype	Vlak gehard glas 4 mm	Overspanningsbescherming	DM 6 kV / CM 10 kV
Optiek	Gemetalliseerde PC-HT reflector	Besturingssysteem	Stand Alone - 1/10V
Pakking	Anti-aging silicone	INSTALLATIE EN ONDERHOUD	
Slothaak	-	Montage en installatie	Verlichting met hoge mast - Wandmontage - Grondmontage
Externe schroef	Rvs	Helling	Rotatie op beugel met geïntegreerde goniometer
Kleur	Polyester poedercoating met epoxy basislaag	Bedrading	Met H07RN-F meerpolige kabel
NORMEN EN GOEDKEURINGEN		Bevestiging	Beugel
Classificatie	-	Vervangbaarheid lichtbron	Door professional
Apparaat met gereduceerde oppervlaktetemperatuur	-	Vervangbaarheid verdeelinrichting	-
DIN 18032-3 certificering	Conform	Driver box	Ingebouwd
IPEA	-	Maximaal oppervlak blootgesteld aan de wind	0,085 m ²
Isolatie klasse	I	-	-
IP graad	IP66	-	-
Mechanische weerstand	IK08	-	-

DIMENSIONAL



PHOTOMETRIC DISTRIBUTION

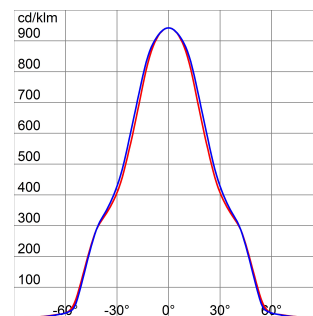

Smart [PRO]e

TECHNICAL SYMBOLOGY



IP
IP66

IK
IK08

STANDARDS/APPROVALS

