

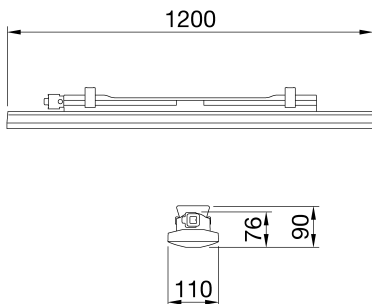

Smart [3]e is a watertight fixture IP66/69 with Mid power LED with wire bonding, available in 4000K,5700K, with CRI ≥80. IK08 body in RAL7035 colored self-exhausting polycarbonate, for industrial applications and ideal for production areas, warehouses, logistics areas and design to replace fluorescent devices and lowbay up to 6,500lm. Available in sizes 800 e 1200mm, powers from 34W to 52W, flux range from 3.700lm to 6.300lm, with integrated Power On/Off and 2 different optical solutions UV-stabilized self-extinguishing polycarbonate, in opal or transparent finish. The version with passing wiring has mechanical and electrical connection components prewired, with up to 25 fixtures installed in a continuous row. The device can be hung or wall mounted and is available a GW bracket accessories with a tilt of 30° or 45° on the vertical axis. Available also with an emergency kit version.

ALGEMENE INFORMATIE		OPTISCHE EN VERLICHTINGSKENMERKEN	
Context	Verlichting van magazijnen, overdekte parkeergarages en industriële productieruimten	Optiek	Microprismatisch transparant
Armatuur	LED-armatuur voor algemene verlichting	Unified Glare Rating	-
Toepassing	Intern	Lumen output (lm)	6300
Unieke digitale code (Datamatrix)	Datamatrix	Effectiviteit (lm/W)	121
Kleur	Grijs RAL 7035	Kleur temperatuur	5700 K
Soort lichtbron	LED	Kleurweergave-index (CRI)	CRI>80
Systeem vermogen	52 W	Kleurconsistentie (SDCM)	SDCM = 3
Levensduur led	L80B20(Tq25 °C)=90.000u - L80B20 (Tq40 °C)=50.000u	Fotobiologisch risicoklasse	-
Gewicht (kg)	2	Standaard	EN60598-1; IEC 62778; IEC62471
Garantie	5 jaar	ELEKTRISCHE EN VERLICHTINGSKENMERKEN	
Opslagtemperatuur	-25 +80 °C	Voeding voltage	220 - 240 V
Bedrijfstemperatuur	-25 +40 °C	Nominale frequentie (Hz)	50/60 Hz
MATERIALEN		Driver	Inbegrepen
Behuizing	Polycarbonaat	Uitvalpercentage driver	F10 = 90.000 u bij Tq 25 °C/F10= 50.000 u bij Tq 40 °C
Schildtype	UV-gestabiliseerd polycarbonaat	Overspanningsbescherming	DM 1 KV / CM 2 KV
Optiek	Geïntegreerd in het scherm	Besturingssysteem	Via bedrading - Aan/Uit
Pakking	CNC afgezet afdichtmiddel	INSTALLATIE EN ONDERHOUD	
Slothaak	-	Montage en installatie	Plafond - Wandmontage - Ophanging
Externe schroef	-	Helling	Met bevestigingsbeugel
Kleur	RAL7035 gekleurde PC-pasta	Bedrading	Met GW connect waterdichte connector
NORMEN EN GOEDKEURINGEN		Bevestiging	Roestvrijstalen steun
Classificatie	-	Vervangbaarheid lichtbron	Niet vervangbaar
Apparaat met gereduceerde oppervlaktetemperatuur	Ja	Vervangbaarheid verdeelinrichting	Niet vervangbaar
DIN 18032-3 certificering	Niet beschikbaar	Driver box	Ingebouwd
IPEA	-	Maximaal oppervlak blootgesteld aan de wind	-
Isolatie klasse	II	-	-
IP graad	IP66/IP69	-	-
Mechanische weerstand	IK08	-	-
Gloeidraadtest	850 °C	-	-

DIMENSIONAL



PHOTOMETRIC DISTRIBUTION

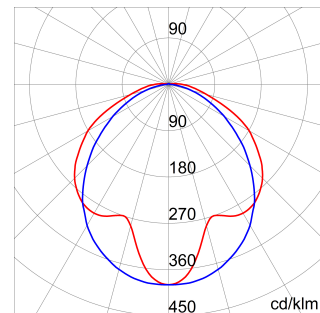

TECHNICAL SYMBOLOGY



IP
IP66/IP69

IK
IK08

GWT
850 °C



Product Data Sheet
GWS3222ET857

SMART [3]e

STANDARDS/APPROVALS

