

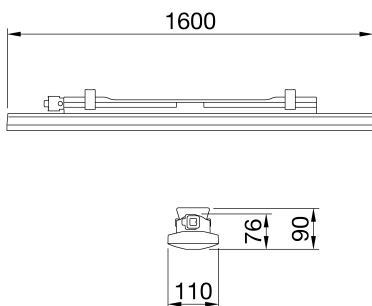

Smart [3] Plus is an IP66/69 ceiling light with LED Flip Type without wire boring, available in 3000K, 4000K, 5700K, with CRI ≥ 80 and ≥ 90 . IK08 body in self-extinguishing polycarbonate RAL7035, for industrial applications and ideal for production areas, warehouses, and logistics areas. Can replace high flux and lowbay fluorescent devices up to 10,000lm. Available in sizes 1200, 1600mm, powers from 38W to 63W, flows from 4,000lm to 10,000lm, with integrated On/Off or DALI power and 3 different optical solutions, Transparent, Opal and Transparent screen with medium-beam optics complete with TIR lens made of PMMA. The version with through wiring has pre-wired mechanical and electrical components, with a maximum of 25 devices installed in a continuous row. It is possible to install the suspension and wall appliance, accessories bracket GW with inclination of 30° or 45° on the vertical axis. An integrated DALI emergency kit version is available.

ALGEMENE INFORMATIE		OPTISCHE EN VERLICHTINGSKENMERKEN	
Context	Verlichting van magazijnen, overdekte parkeergarages en industriële productieruimten	Optiek	Microprismatisch transparant
Armatuur	LED-armatuur voor algemene verlichting	Unified Glare Rating	-
Toepassing	Intern	Lumen output (lm)	6600 (550 Nood)
Unieke digitale code (Datamatrix)	Datamatrix	Effectiviteit (lm/W)	120
Kleur	Grijs RAL 7035	Kleur temperatuur	5700 K
Soort lichtbron	LED	Kleurweergave-index (CRI)	CRI>80
Systeem vermogen	50 W (+5 W Nood)	Kleurconsistentie (SDCM)	SDCM = 5
Levensduur led	L90B10(Tq25 °C)=50.000u; L80B10(Tq25 °C)=100.000u; L80B10(Tq50 °C)=94.000u	Fotobiologisch risicoklasse	RG0
Gewicht (kg)	4.4	Standaard	EN60598-1; IEC 62778; IEC62471
Garantie	5 jaar	ELEKTRISCHE EN VERLICHTINGSKENMERKEN	
Opslagtemperatuur	-25 +80 °C	Voeding voltage	220 - 240 V
Bedrijfstemperatuur	-25 +50 °C	Nominale frequentie (Hz)	50/60 Hz
MATERIALEN		Driver	Inbegrepen
Behuizing	Polycarbonaat	Uitvalpercentage driver	F10 = 100.000u Tq25 °C
Schildtype	UV-gestabiliseerd polycarbonaat	Overspanningsbescherming	DM 1 KV / CM 2 KV
Optiek	Geïntegreerd in het scherm	Besturingssysteem	DALI
Pakking	CNC afgezet afdichtmiddel	INSTALLATIE EN ONDERHOUD	
Slothaak	-	Montage en installatie	Plafond - Wandmontage - Ophanging
Externe schroef	-	Helling	Met bevestigingsbeugel
Kleur	RAL7035 gekleurde PC-pasta	Bedrading	Met GW connect waterdichte connector
NORMEN EN GOEDKEURINGEN		Bevestiging	Roestvrijstalen steun
Classificatie	KITE MARK (Noodkit)	Vervangbaarheid lichtbron	Niet vervangbaar
Apparaat met gereduceerde oppervlaktetemperatuur	Ja	Vervangbaarheid verdeelinrichting	Niet vervangbaar
DIN 18032-3 certificering	Niet beschikbaar	Driver box	Ingebouwd
IPEA	-	Maximaal oppervlak blootgesteld aan de wind	-
Isolatie klasse	II	-	-
IP graad	IP65	-	-
Mechanische weerstand	IK08	-	-
Gloeidraadtest	850 °C	-	-

DIMENSIONAL



PHOTOMETRIC DISTRIBUTION

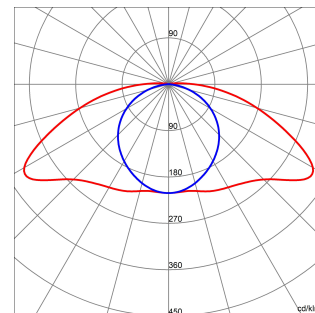

TECHNICAL SYMBOLOGY



IP

IP65

IK

IK08

GWT

850 °C



Product Data Sheet

GWS3325AB857

SMART [3] PLUS

STANDARDS/APPROVALS

