



Smart [3] Plus is an IP66/69 ceiling light with LED Flip Type without wire boring, available in 3000K, 4000K, 5700K, with CRI ≥ 80 and ≥ 90 . IK08 body in self-extinguishing polycarbonate RAL7035, for industrial applications and ideal for production areas, warehouses, and logistics areas. Can replace high flux and lowbay fluorescent devices up to 10,000lm. Available in sizes 800, 1200, 1600mm, powers from 25W to 63W, flows from 4,000lm to 10,000lm, with integrated On/Off or DALI power and 3 different optical solutions, Transparent, Opal and Transparent screen with medium-beam optics complete with TIR lens made of PMMA. The version with through wiring has pre-wired mechanical and electrical components, with a maximum of 25 devices installed in a continuous row. It is possible to install the suspension and wall appliance, accessories bracket GW with inclination of 30° or 45° on the vertical axis. An emergency kit version is available.

ALGEMENE INFORMATIE

Context	Verlichting van magazijnen, overdekte parkeergarages en industriële productieruimten
Armatuur	LED-armatuur voor algemene verlichting
Toepassing	Intern
Unieke digitale code (Datamatrix)	Datamatrix
Kleur	Grijs RAL 7035
Soort lichtbron	LED
Systeem vermogen	50 W
Levensduur led	L90B10(Tq25 °C)=50.000u; L80B10(Tq25 °C)=100.000u; L80B10 (Tq50 °C)=94.000u
Gewicht (kg)	3,8
Garantie	5 jaar
Opslagtemperatuur	-25 +80 °C
Bedrijfstemperatuur	-25 +50 °C

MATERIALEN	
Behuizing	Polycarbonaat
Schildtype	UV-gestabiliseerd polycarbonaat
Optiek	Geïntegreerd in het scherm
Pakking	CNC afgezet afdichtmiddel
Slothaak	-
Externe schroef	-
Kleur	RAL7035 gekleurde PC-pasta

NORMEN EN GOEDKEURINGEN	
Classificatie	-
Apparaat met gereduceerde oppervlaktetemperatuur	Ja
DIN 18032-3 certificering	Niet beschikbaar
IPEA	-
Isolatie klasse	II
IP graad	IP66/IP69
Mechanische weerstand	IK08
Gloeidraadtest	850 °C

OPTISCHE EN VERLICHTINGSKENMERKEN

Optiek	Breed opaal
Unified Glare Rating	UGR ≤ 25 (4H/8H)
Lumen output (lm)	5600
Effectiviteit (lm/W)	112
Kleur temperatuur	4000 K
Kleurweergave-index (CRI)	CRI > 90
Kleurconsistentie (SDCM)	SDCM = 3
Fotobiologisch risicoklasse	RG0
Standaard	EN60598-1; IEC 62778; IEC62471

ELEKTRISCHE EN VERLICHTINGSKENMERKEN

Voeding voltage	220-240 V
Nominale frequentie (Hz)	50/60 Hz
Driver	Inbegrepen
Uitvalpercentage driver	F10 = 100.000u Tq25 °C
Overspanningsbescherming	DM 1 KV / CM 2 KV
Besturingssysteem	Stand Alone - DALI

INSTALLATIE EN ONDERHOUD

Montage en installatie	Plafond - Wandmontage - Ophanging
Helling	Met bevestigingsbeugel
Bedrading	Met GW connect waterdichte connector
Bevestiging	Roestvrijstalen steun
Vervangbaarheid lichtbron	Niet vervangbaar
Vervangbaarheid verdeelinrichting	Niet vervangbaar
Driver box	Ingebouwd
Maximaal oppervlak blootgesteld aan de wind	-

DIMENSIONAL

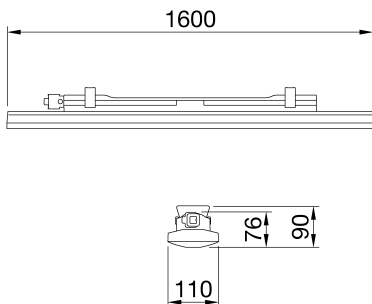

PHOTOMETRIC DISTRIBUTION

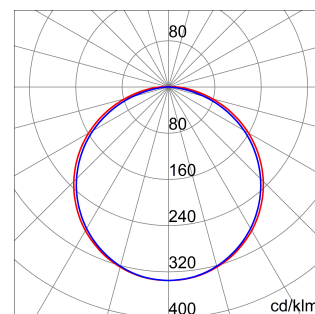

TECHNICAL SYMBOLOGY



IP
IP66/IP69

IK
IK08

GWT
850 °C



Product Data Sheet

GWS3321AP940

SMART [3] PLUS

STANDARDS/APPROVALS

