

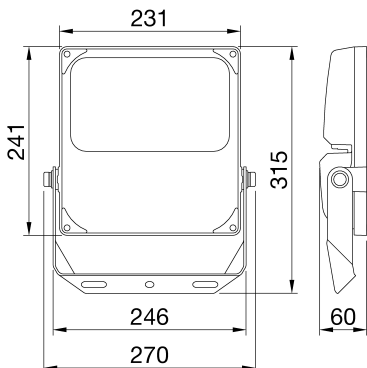

ELIA FL is an LED floodlight, available in medium and high-power versions for outdoor and indoor applications in industrial, tertiary and sports contexts, such as façades, warehouses, car parks and sports fields. Available in 4 different sizes and power steps (50 W, 100 W, 150 W and 200 W), the range allows for great flexibility with its multiple possible combinations: 3 colour temperature options (3,000 K warm white, 4,000 K neutral white and 5,700 K cool white) with a colour rendering index of more than 80; 2 integrated power supply options (On/Off and DALI); and 2 optics options (60° and asymmetrical). The luminaire can be ceiling, wall or floor-mounted through the integrated adjustable steel bracket with a protractor, or pole-mounted (in poles with diameter up to 61 mm) through a dedicated accessory (to be ordered separately). Thanks to its black powder-coated die-cast aluminium body and its front glass, the fixture is tough, durable (IP66 and IK08) and is able to withstand harsh environmental conditions (such as ambient temperature variations from -30°C to +50°C).

ALGEMENE INFORMATIE		OPTISCHE EN VERLICHTINGSKENMERKEN	
Context	Industrie, logistiek, gevels, sportfaciliteiten en buitenverlichting	Optiek	Assymetrisch
Armatuur	LED-armatuur met gemiddeld en hoog lumenvermogen	Unified Glare Rating	ULOR = 0%
Toepassing	Binnen / Buiten	Lumen output (lm)	13400
Unieke digitale code (Datamatrix)	Momenteel niet aanwezig	Effectiviteit (lm/W)	134
Kleur	Zwart	Kleur temperatuur	5700 K
Soort lichtbron	LED	Kleurweergave-index (CRI)	CRI 80
Systeem vermogen	100 W	Kleurconsistentie (SDCM)	SDCM = 5
Levensduur led	L80B50 (Tq=25 °C) = 80.000 u	Fotobiologisch risicoklasse	RG1
Gewicht (kg)	2.6	Standaard	EN 60598-1; EN 60598-2-5; IEC/TR 62778; EN 62493
Garantie	5 jaar	ELEKTRISCHE EN VERLICHTINGSKENMERKEN	
Opslagtemperatuur	-40° +80°	Voeding voltage	220-240 V
Bedrijfstemperatuur	-30 °C ÷ +50 °C	Nominale frequentie (Hz)	50/60 Hz
MATERIALEN		Driver	Ingebouwd
Behuizing	Gegoten aluminium	Uitvalpercentage driver	F10 (Tq=25 °C) > 80.000 u
Schildtype	Gehard glas met 4 mm dik oppervlak met Gewiss-logo	Overspanningsbescherming	DM 4 kV/ CM 4 kV
Optiek	Zeer efficiënte lens- en reflectoreenheid	Besturingssysteem	AAN / UIT
Pakking	-	INSTALLATIE EN ONDERHOUD	
Slothaak	-	Montage en installatie	Schijnwerpermast - Plafond - Wand - Grond
Externe schroef	Rvs	Helling	Rotatie op beugel met geïntegreerde goniometer
Kleur	Poedercoating	Bedrading	Met voedingskabel
NORMEN EN GOEDKEURINGEN		Bevestiging	Via geïntegreerde beugel
Classificatie	-	Vervangbaarheid lichtbron	Niet vervangbaar
Apparaat met gereduceerde oppervlaktetemperatuur	-	Vervangbaarheid verdeelinrichting	Door professional
DIN 18032-3 certificering	Niet beschikbaar	Driver box	Ingebouwd
IPEA	-	Maximaal oppervlak blootgesteld aan de wind	0,055 m2
Isolatie klasse	I		Ingebouwd
IP graad	IP66		-
Mechanische weerstand	IK08		-
Gloeidraadtest	750 °C		-

DIMENSIONAL



PHOTOMETRIC DISTRIBUTION

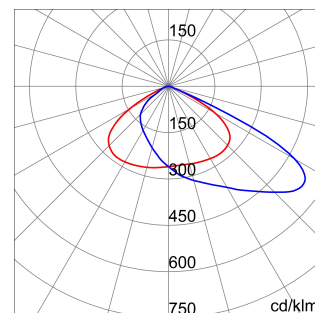

TECHNICAL SYMBOLOGY





Product Data Sheet
GWF1100NC857

ELIA FL

STANDARDS/APPROVALS

