

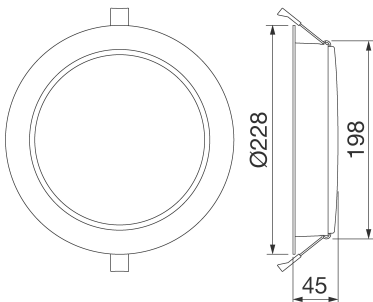

ELIA DL Flush-mounting LED downlight for lighting entrance areas, corridors and shared spaces, crafted from white power-coated die-cast aluminium with an opal diffusing shield. It is available in two power versions, with separate electronic power supply in the On/Off or DALI options provided as part of a kit, colour temperature of 4,000 K (neutral white) and colour rendering index of more than 80 or more than 90. ELIA DL has been designed to withstand temperature variations from -20°C to + 45°C, and offers protection from water and dust penetration of up to level IP54 and from shocks and impacts of up to level IK06. Light and easy to handle, ELIA DL is easy to install thanks to the connector for the electrical wiring and the quick, simple fin-locking mechanism.

ALGEMENE INFORMATIE		OPTISCHE EN VERLICHTINGSKENMERKEN	
Context	Binnenverlichting	Optiek	Breed opaal
Armatuur	LED-armatuur voor diffuus licht	Unified Glare Rating	-
Toepassing	Intern	Lumen output (lm)	3300
Unieke digitale code (Datamatrix)	Momenteel niet aanwezig	Effectiviteit (lm/W)	94
Kleur	Wit	Kleur temperatuur	4000 K
Soort lichtbron	LED	Kleurweergave-index (CRI)	CRI 90
Systeem vermogen	35 W	Kleurconsistentie (SDCM)	SDCM = 3
Levensduur led	L80B50 (Tq25°) = 50.000u	Fotobiologisch risicoklasse	RG0
Gewicht (kg)	0.8	Standaard	EN 60598-1; EN 60598-2-2; IEC/TR 62778; EN 62493
Garantie	5 jaar	ELEKTRISCHE EN VERLICHTINGSKENMERKEN	
Opslagtemperatuur	-20° +65°	Voeding voltage	220-240 V
Bedrijfstemperatuur	-20° +45°	Nominale frequentie (Hz)	50 / 60
MATERIALEN		Driver	Extern - Inbegrepen
Behuizing	Gegoten aluminium	Uitvalpercentage driver	F025 (Tq=25 °C) = 50.000u
Schildtype	Polycarbonaat	Overspanningsbescherming	DM 1 kV
Optiek	Opalen polycarbonate afscherming	Besturingssysteem	DALI
Pakking	-	INSTALLATIE EN ONDERHOUD	
Slothaak	-	Montage en installatie	Voor inbouw
Externe schroef	-	Helling	-
Kleur	Poedercoating	Bedrading	Met aansluitklem op driver
NORMEN EN GOEDKEURINGEN		Bevestiging	Via veren geïntegreerd in de armatuur
Classificatie	-	Vervangbaarheid lichtbron	Niet vervangbaar
Apparaat met gereduceerde oppervlaktetemperatuur	-	Vervangbaarheid verdeelinrichting	Door professional
DIN 18032-3 certificering	Niet beschikbaar	Driver box	-
IPEA	-	Maximaal oppervlak blootgesteld aan de wind	-
Isolatie klasse	II	-	-
IP graad	IP40 - IP54	-	-
Mechanische weerstand	IK06	-	-
Gloeidraadtest	650 °C	-	-

DIMENSIONAL



PHOTOMETRIC DISTRIBUTION

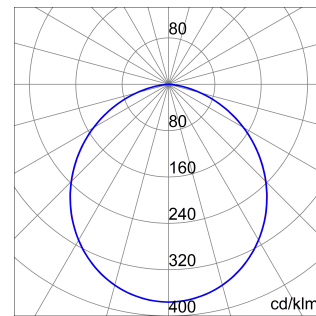

TECHNICAL SYMBOLOGY



IP

IP40 - IP54

IK

IK06

GWT

650 °C

STANDARDS/APPROVALS



Data, measures, designs and pictures are for information purpose only, last update 25/11/2024. They can be changed at any moment, therefore it is always recommended to read the last updated version published on the website www.gewiss.com. Lumen output and system power are subject to a tolerance of +/- 10%. Unless stated otherwise, the values apply to an ambient temperature of 25°C. Terms of warranty at <https://www.gewiss.com/it/en/company/landingpage/led-warranty>. - 1 of 1