

Smart [PRO] 2.0
Geïntegreerde oplossing voor professionele sportaccomodaties en grote buitenruimtes



SMART [PRO] 2.0 is a high power outdoor and indoor LED projector, suitable for lighting large areas and sports facilities. It can be installed on the wall, ceiling or ground thanks to the polyester powder coated galvanised steel bracket with trivalent passivation, equipped with adjustable goniometric scale and supplied in a kit. The body is fabricated in aluminium die casting EN AB 46100, with integrated passive heat dissipation, powder-coated polyester paint with trivalent passivation. PCB metal core with CSP LED. Reflector made of metallic HT PC or anodised and polished aluminium. Hardened front glass with 4mm thickness, anti-ageing silicone seals and A2 stainless steel exterior screws. Bracket screws with GEOMET® treatment. Plastic venting and anti-condensation device. Insulation class 1. Remote power supply unit in DALI or DMX options, multiple electrical connection kits, supplied separately. Available with nine different types of optics, three types of Colour Temperature (3,000/4,000K/5,700K) and three different types of Color Rendering Index (CRI>70, CRI>80, CRI>90). Designed to withstand surges up to 5KV (RCCB mode) and 10KV (common mode), temperature variations from -30°C to +50°C, water and dust penetration up to IP66 protection grade and shockproof up to IK08 grade.

ALGEMENE INFORMATIE		OPTISCHE EN VERLICHTINGSKENMERKEN	
Context	Sport, grote gebieden	Optiek	C3 - Cirkelvormig 20°
Armatuur	LED-armatuur met gemiddeld en hoog lumenvermogen	Unified Glare Rating	G*6 - ULOR = 0
Toepassing	Binnen / Buiten	Lumen output (lm)	122700
Unieke digitale code (Datamatrix)	Momenteel niet aanwezig	Effectiviteit (lm/W)	126
Kleur	Grafietgrijs	Kleur temperatuur	4000 K
Soort lichtbron	LED	Kleurweergave-index (CRI)	CRI>70
Systeem vermogen	970 W	Kleurconsistentie (SDCM)	SDCM = 5
Levensduur led	L90B10(Tq25 °C)=40.000u; L80B10 (Tq25 °C)=90.000u	Fotobiologisch risicoklasse	-
Gewicht (kg)	29	Standaard	EN60598-1; EN60598-2-5; IEC 62778; IEC 62471; EN13201
Garantie	5 jaar	ELEKTRISCHE EN VERLICHTINGSKENMERKEN	
Opslagtemperatuur	-	Voeding voltage	-
Bedrijfstemperatuur	-30 °C ÷ +50 °C	Nominale frequentie (Hz)	-
MATERIALEN		Driver	Moet afzonderlijk worden besteld
Behuizing	Gegoten aluminium	Uitvalpercentage driver	Zie externe verzorgingseenheid
Schildtype	Vlak gehard glas 4 mm	Overspanningsbescherming	Zie externe verzorgingseenheid
Optiek	Gepolijste kwarts en gemetalliseerde PC HT reflector	Besturingssysteem	Zie externe verzorgingseenheid
Pakking	Anti-aging silicone	INSTALLATIE EN ONDERHOUD	
Slothaak	Hexagonale metrische schroeven	Montage en installatie	Verlichting met hoge mast - Wandmontage - Grondmontage
Externe schroef	Rvs	Helling	Rotatie op beugel met geïntegreerde goniometer
Kleur	Polyester poedercoating	Bedrading	Waterdichte connector
NORMEN EN GOEDKEURINGEN		Bevestiging	Beugel
Classificatie	-	Vervangbaarheid lichtbron	Door professional
Apparaat met gereduceerde oppervlaktetemperatuur	Aant.	Vervangbaarheid verdeelinrichting	-
DIN 18032-3 certificering	Beschikbaar	Driver box	Extern
IPEA	-	Maximaal oppervlak blootgesteld aan de wind	0,333 m2
Isolatie klasse	I	-	-
IP graad	IP66	-	-
Mechanische weerstand	IK08	-	-
Gloeidraadtest	-	-	-

DIMENSIONAL

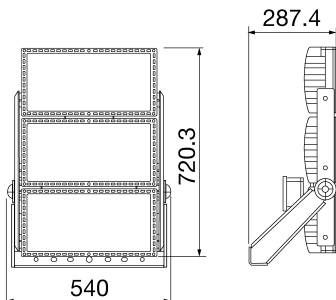

PHOTOMETRIC DISTRIBUTION

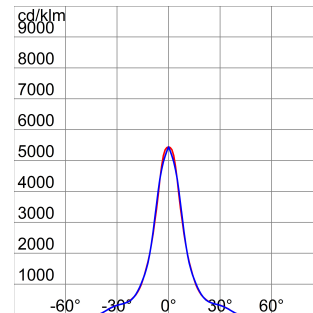

Smart [PRO] 2.0
Geïntegreerde oplossing voor professionele sportaccomodaties en grote buitenruimtes

TECHNICAL SYMBOLOGY



IP
IP66

IK
IK08

GWT
-

STANDARDS/APPROVALS

