



SMART [PRO] 2.0 is a medium power outdoor and indoor LED projector, suitable for lighting sports areas and facilities. It can be installed on the wall, ceiling or ground thanks to the polyester powder coated galvanised steel bracket, with trivalent passivation, equipped with adjustable goniometric scale and supplied in kit. The body is produced in aluminium die casting

EN AB 46100, with integrated passive heat sink, powder coated polyester with trivalent passivation. Metal core PCB with CSP LED.

Reflector made of metallic HT PC or anodised and polished aluminium. Hardened front glass with 4mm thickness, anti-ageing silicone seals and A2 stainless steel exterior screws. Plastic venting and anti-condensation device. Electrical connection via IP68 connector for 1.5mm2 cables. Insulation class 1.

Driver integrated in options 1-10 V or DALI. Available with nine different types of optics, three types of Colour Temperature (3,000K/4,000K/5,700K) and two different types of Chromatic Yield Index (CRI>70, CRI>80).

Designed to withstand surges up to 5KV (RCCB mode) and 10KV (common mode), temperature variations from -30°C to +50°C, water and dust penetration up to IP66 protection and impacts up to IK08.

ALGEMENE INFORMATIE		OPTISCHE EN VERLICHTINGSKENMERKEN	
Context	Sport, grote gebieden	Optiek	C4 - Cirkelvormig 15°
Armatuur	LED-armatuur met klein, middelgroot en hoog lumenvermogen	Unified Glare Rating	G*6 - ULOR = 0
Toepassing	Binnen / Buiten	Lumen output (lm)	20500
Unieke digitale code (Datamatrix)	Momenteel niet aanwezig	Effectiviteit (lm/W)	124
Kleur	Grafietgrijs	Kleur temperatuur	5700 K
Soort lichtbron	LED	Kleurweergave-index (CRI)	CRI>70
Systeem vermogen	165 W	Kleurconsistentie (SDCM)	SDCM = 5
Levensduur led	L90B10(Tq25 °C)=50.000u; L80B10 (Tq25 °C)=110.000u	Fotobiologisch risicoklasse	-
Gewicht (kg)	5.7	Standaard	EN60598-1; EN60598-2-5; EN60598-2-24; IEC 62778; IEC62471; EN13201
Garantie	5 jaar	ELEKTRISCHE EN VERLICHTINGSKENMERKEN	
Opslagtemperatuur	-	Voeding voltage	220 - 240 V
Bedrijfstemperatuur	-30 °C ÷ +50 °C	Nominale frequentie (Hz)	50 / 60
MATERIALEN		Driver	Inbegrepen
Behuizing	Gegoten aluminium -	Uitvalpercentage driver	F10 = 100.000u Tq25 °C
Schildtype	Vlak gehard glas 4 mm	Overspanningsbescherming	DM 6 kV / CM 10 kV
Optiek	Gepolijste kwarts en gemetalliseerde PC HT reflector	Besturingssysteem	DALI
Pakking	Anti-aging silicone	INSTALLATIE EN ONDERHOUD	
Slothaak	Hexagonale metrische schroeven	Montage en installatie	Verlichting met hoge mast - Wandmontage - Grondmontage
Externe schroef	Rvs	Helling	Rotatie op beugel met geïntegreerde goniometer
Kleur	Polyester poedercoating	Bedrading	Waterdichte connector
NORMEN EN GOEDKEURINGEN		Bevestiging	Beugel
Classificatie	-	Vervangbaarheid lichtbron	Door professional
Apparaat met gereduceerde oppervlaktetemperatuur	Ja	Vervangbaarheid verdeelinrichting	Door professional
DIN 18032-3 certificering	Beschikbaar	Driver box	Ingebouwd
IPEA	-	Maximaal oppervlak blootgesteld aan de wind	0,085 m2
Isolatie klasse	I		-
IP graad	IP66		-
Mechanische weerstand	IK08		-
Gloeidraadtest	-		-

DIMENSIONAL

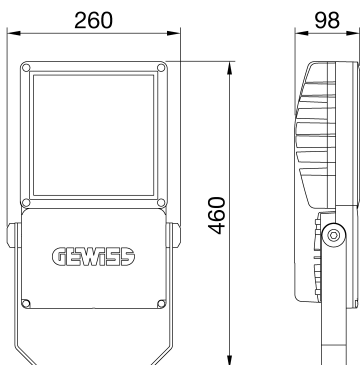

PHOTOMETRIC DISTRIBUTION

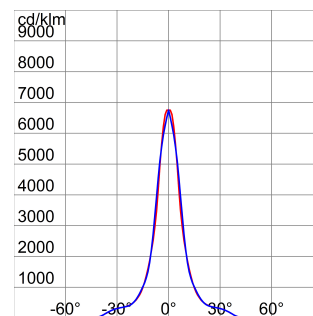

Smart [PRO] 2.0

Geïntegreerde oplossing voor professionele sportaccomodaties en grote buitenruimtes

TECHNICAL SYMBOLOGY



0,085 m2



IP
IP66

IK
IK08

GWT
-

STANDARDS/APPROVALS

