

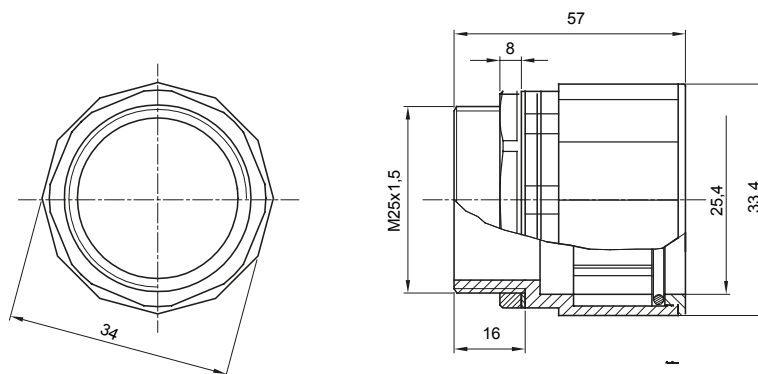

Routingonderdelen voor rigide beschermende buizen met beschermingsgraad IP40 en IP67.

Kleur	Grijs RAL 7035	IP graad	IP67
ISO pitch	M 25 x 1,5	Voor gaten Ø (mm)	25
Buizen Ø (mm)	25	Type materiaal	Halogeenvrij conform EN 50642
Electrocod	21221		

DIMENSIONAL



TECHNICAL SYMBOLOGY

IP

HF
HALOGEN FREE

IP67

STANDARDS/APPROVALS

