

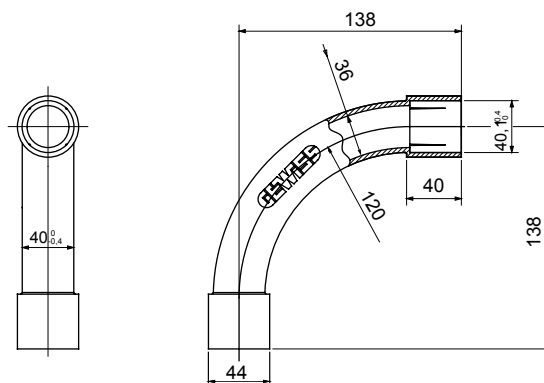

Routingonderdelen voor rigide beschermende buizen met beschermingsgraad IP40 en IP67.

Kleur	Grijs RAL 7035	IP graad	IP40
Buizen Ø (mm)	40	Type materiaal	Halogenvrij conform EN 50642
Electrocod	21221		

### DIMENSIONAL



### TECHNICAL SYMBOLOGY

**IP**

**HF**  
HALOGEN FREE

IP40

### STANDARDS/APPROVALS

