

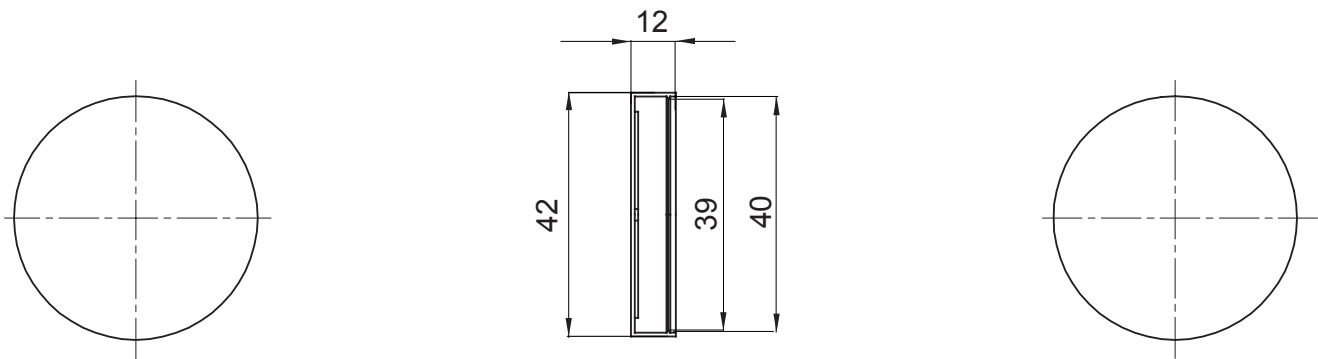

Kleur	Grijs RAL 7035	Materiaal	PP
Buizen Ø (mm)	40	Electrocod	210

DIMENSIONAL



STANDARDS/APPROVALS

