

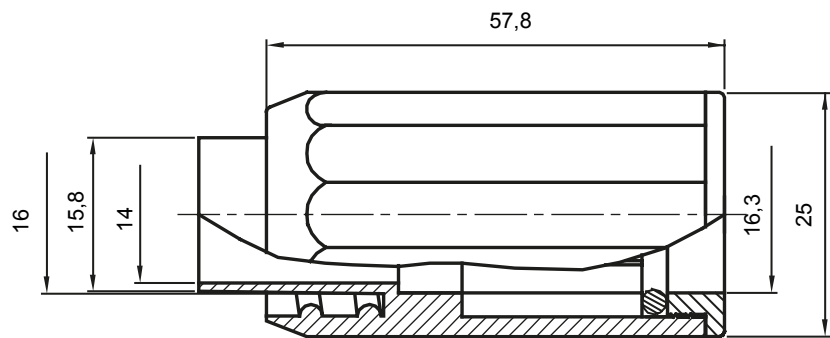

Routingonderdelen voor rigide beschermende buizen met beschermingsgraad IP40 en IP67.

Kleur	Grijs RAL 7035	IP graad	IP65
Buizen Ø (mm)	16	Schacht Ø (mm)	16
Type materiaal	Halogeenvrij conform EN 50642	Electrocod	21221

### DIMENSIONAL

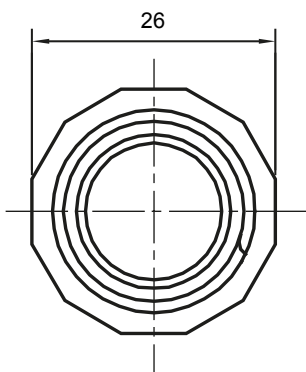

### TECHNICAL SYMBOLOGY

**IP**

**HF**  
HALOGEN FREE

IP65

### STANDARDS/APPROVALS

