

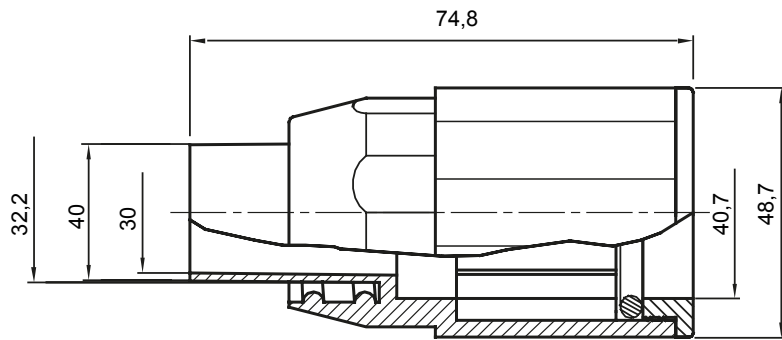

Routingonderdelen voor rigide beschermende buizen met beschermingsgraad IP40 en IP67.

Kleur	Grijs RAL 7035	IP graad	IP65
Buizen Ø (mm)	40	Schacht Ø (mm)	32
Type materiaal	Halogeenvrij conform EN 50642	Electrocod	21221

DIMENSIONAL

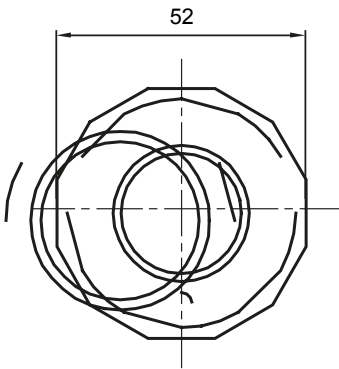

TECHNICAL SYMBOLOGY

IP

HF
HALOGEN FREE

IP65

STANDARDS/APPROVALS

