

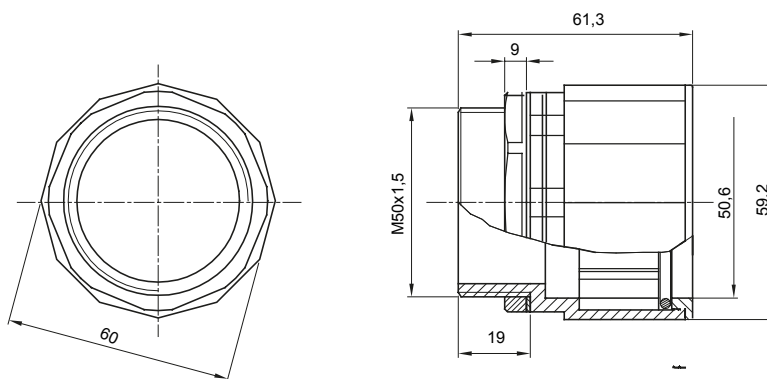

Routingonderdelen voor rigide beschermende buizen met beschermingsgraad IP40 en IP67.

Kleur	Grijs RAL 7035	IP graad	IP67
ISO pitch	M 50 x 1,5	Voor gaten Ø (mm)	50
Buizen Ø (mm)	50	Type materiaal	Halogeenvrij conform EN 50642
Electrocod	21221		

### DIMENSIONAL



### TECHNICAL SYMBOLOGY

**IP**

**HF**  
HALOGEN FREE

IP67

### STANDARDS/APPROVALS

