

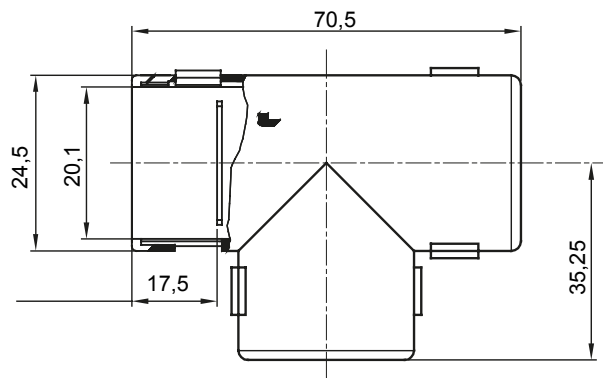

Routingonderdelen voor rigide beschermende buizen met beschermingsgraad IP40 en IP67.

Kleur	Grijs RAL 7035	IP graad	IP40
Buizen Ø (mm)	20	Electrocod	21221

DIMENSIONAL

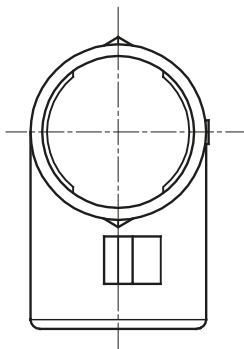

TECHNICAL SYMBOLOGY

IP

IP40

STANDARDS/APPROVALS

